



Replacement Research Reactor Project

SAR CHAPTER 4 BUILDINGS AND STRUCTURES

Prepared By



For

Australian Nuclear Science and Technology Organisation

1 November 2004

Page 1 of 73

ANSTO		Document N°: RRRP-7225-EBEAN-002-Rev0-CHAPTER-04 Revision: 0		
Replacement Reactor Project		Document Title: SAR – Chapter 4, Buildings and Structures		
REVISION SHEET		Ref No:		
		Print name, date and sign or initial		
Revision	Description of Revision	Prepared	Checked/ Reviewed	Approved
0	Original issue for public release	SH	RPH	GW
Notes: 1. Revision must be verified in accordance with the Quality Plan for the job.				

TABLE OF CONTENTS

- 4 BUILDINGS AND STRUCTURES**
- 4.1 Introduction and objectives**
- 4.2 Overview of Buildings and Structures Comprising the Reactor Facility**
- 4.3 Design Bases for the buildings and structures comprising the reactor facility**
 - 4.3.1 Introduction
 - 4.3.2 Principal Design Codes
 - 4.3.2.1 Seismic Design
 - 4.3.2.2 Structural Design
 - 4.3.3 Design Loads
 - 4.3.3.1 Plant Process Loads:
 - 4.3.3.2 Environmental Loads
 - 4.3.3.3 Other Design Features
- 4.4 Reactor Building**
 - 4.4.1 Design Concept
 - 4.4.2 Architectural Design
 - 4.4.2.1 General Considerations
 - 4.4.2.2 Circulation of Personnel and Equipment
 - 4.4.2.3 Emergency Exits
 - 4.4.2.4 Radiological Protection
 - 4.4.2.5 Security
 - 4.4.2.6 Fire
 - 4.4.3 Structural Design
 - 4.4.3.1 Design Criteria
 - 4.4.3.2 Evaluation of Loads
 - 4.4.3.3 Analysis and Design
 - 4.4.3.4 Structure Description
 - 4.4.3.5 Materials and Construction
 - 4.4.4 Air-locks, Hatches and Penetrations
- 4.5 Reactor Building Internal Structures & Systems**
 - 4.5.1 Reactor Pool and Service Pool
 - 4.5.1.1 Introduction
 - 4.5.1.2 System Categorisation
 - 4.5.1.3 Safety Functions
 - 4.5.1.4 Codes and Standards
 - 4.5.1.5 Reactor Pool
 - 4.5.1.6 Service Pool
 - 4.5.1.7 Transfer Canal
 - 4.5.1.8 Operations Bridge
 - 4.5.1.9 Fabrication of Components
 - 4.5.1.10 Shipment and Installation
 - 4.5.1.11 Inspection and Testing
 - 4.5.2 Cranes
 - 4.5.2.1 Reactor Hall Crane
 - 4.5.2.2 Reactor Beam Hall Crane
 - 4.5.2.3 Radioisotope Flask Hoist
 - 4.5.2.4 Hoists and Lifting Devices
- 4.6 Neutron Guide Hall**
 - 4.6.1 Architectural Layout
 - 4.6.2 Structure
 - 4.6.3 Internal Services

- 4.6.3.1 Cranes
- 4.6.4 Access to and from the Neutron Guide Hall
 - 4.6.4.1 Normal Staff Movement within the NGH
 - 4.6.4.2 Emergency Exits and Access
- 4.6.5 Bunker and Associated Shielding

- 4.7 Auxiliary Services Building and Facility Substation**
 - 4.7.1 Description
 - 4.7.1.1 Auxiliary Building Crane
 - 4.7.1.2 Other Services

- 4.8 Main Entrance, Conference Centre and Group Tour Areas**
 - 4.8.1 Description

- 4.9 Other Structures**
 - 4.9.1 Cooling Towers
 - 4.9.2 Reactor Stack

End of Table of Contents

4 BUILDINGS AND STRUCTURES

4.1 INTRODUCTION AND OBJECTIVES

The objectives of this Chapter are:

- a) To provide a description of the buildings, structures and facilities.
- b) To identify the safety features of the buildings and structures that contribute to nuclear and personnel safety.
- c) To identify the specific safety requirements and safety design bases from other Chapters that are applicable to the buildings and structures.
- d) To evaluate the design of the buildings and structures so as to demonstrate that they meet the identified safety requirements and safety design bases.

The Chapter covers the following issues:

- a) The building design and site layout (eg access control, radiation protection and shielding).
- b) The integrity of the reactor block during design basis and beyond design basis events.
- c) The capability of the buildings and structures to withstand external hazards such as a seismic event or an aircraft crash.

End of Section

4.2 OVERVIEW OF BUILDINGS AND STRUCTURES COMPRISING THE REACTOR FACILITY

The Reactor Facility comprises the following buildings and structures:

- a) The Reactor Building – this building houses the reactor block, the main reactor systems and most Engineered Safety Features.
- b) The Neutron Guide Hall
- c) The Main Entrance, Conference Centre and Group Tour Areas
- d) The Auxiliary Services Buildings and other structures

In locating the main buildings within the site allocated by ANSTO, a number of factors have been considered, including:

- a) Integration of the activities within the new facility with the functioning of the LHSTC as a whole, including all safety-related issues such as emergency arrangements.
- b) Provision for possible expansion of offices and Neutron Guide Hall
- c) Adequate clearance from the site boundary, provision for fuel free and fuel reduced zones for bushfire control.
- d) Access and circulation of personnel and visitors
- e) Access to building services
- f) Landscaping and road services
- g) Environmental issues such as stormwater management
- h) Security requirements
- i) Fire protection and Building Code of Australia (BCA).

An important requirement affecting the layout of the Reactor Facility has been the need to optimise the relative locations of the neutron sources in the reactor block and the recipient neutron beam instruments, in addition to allowing the possible future construction of a second Neutron Guide Hall. The chosen solution has enabled the two sets of Cold Neutron and Thermal Neutron Guides to be located in almost opposite sides of the reactor block along a north-south axis. As a result, the Reactor Building is located in the centre of the site with the Neutron Guide Hall extending to one end, allowing space for the possible future Neutron Guide Hall to the other as well as possible office blocks on the north and south sides of the Main Entrance.

Single storey buildings containing instrument cabins and laboratories adjoin the eastern and western sides of the Neutron Guide Hall. A separate curved building contains the main Entry Foyer plus staff amenities, conference and display areas. Administrative staff, researchers, scientists and chemistry facilities are accommodated around a courtyard in a single storey building adjoining the eastern side of the Reactor Building.

Immediately next to the Reactor Building is an Auxiliary Services Building containing electrical equipment and other services related plant. A bank of cooling towers to service the complex are set the site with pipelines and pumping systems connected to the main buildings.

The elevation of the major features of the facility are defined in metres above or below this local datum. The reactor ventilation stack extends above the Reactor Building above

Level 0.00. Layout details of the floors and levels within the Reactor Building are given in Section 4.4.2 of this Chapter.

End of Section

4.3 DESIGN BASES FOR THE BUILDINGS AND STRUCTURES COMPRISING THE REACTOR FACILITY

4.3.1 Introduction

The Reactor Facility has been designed in accordance with the appropriate Australian and international design standards which represent best practice for a facility of this type.

The Reactor Facility has been designed to support dead loads, live loads and seismic events in combination.

The serviceability of the Reactor Facility has been addressed in the design, in relation to the fitness for purpose of the discrete facility buildings. Factors included in this review have included containment, reactor core protection, radiation shielding, reliability, durability, deflection, cracking, impermeability, acoustics and sound transmission.

4.3.2 Principal Design Codes

The principal design codes adopted in the design of the Reactor Facility are as follows:

4.3.2.1 Seismic Design

Structures shall comply with the criteria specified in Chapter 2, Section 2.6.1.7, listed in accordance to IAEA Safety Guide 50-SG-D15 (“Seismic Design and Qualification for Nuclear Power Plants”).

Three seismic categories have been selected from Chapter 2, Section 2.5.2. The seismic categories are:

Seismic Category 1: The item shall be designed to withstand the SL-2

Seismic Category 2: The item shall be designed to withstand the SL-1

Seismic Category 3: The item shall be designed to withstand the SL-0

Note:

SL-2 applies to the Safe Shutdown Earthquake (SSE)

SL-1 applies to the Operational Basis Earthquake (OBE)

SL-0 applies to the structures designed in accordance with AS1170.4.

The Reactor Building and the main parts of the Auxiliary Services Building have been designed to Seismic Category 1, the access to the Reactor Building and the remaining parts of the Auxiliary Services Building to Seismic Category 2, and the Neutron Guide Hall to Seismic Category 3. The failure modes of the Seismic Category 2 and 3 areas have been designed as “fail safe” with respect to Seismic Category 1 areas.

The Seismic Category 1 & 2 buildings and structures have been designed to take account of the dynamic response to earthquake loads. For these buildings the oscillatory modes are first evaluated and then the effective forces determined by means of Response Spectra Analysis method.

The Time History Analysis method is also used in Seismic Category 1 and 2 structures in order to generate the Floor Response Spectra. These spectra have been taken as dynamic input to design the equipment and components in all the levels in the facility.

The Reactor Facility structures are analysed using 3 dimensional finite element models which take into account the geometry of the facility buildings, the distribution of masses and stiffness of the structural members.

The Seismic Category 3 buildings are designed using the Equivalent Static Method.

4.3.2.2 Structural Design

The following design codes have also been used:

American Concrete Institute Building Code Requirements for Structural Concrete, for seismic category 1 and 2 structures.

Code Requirements for Nuclear Safety Related Concrete Structures, for loads combinations of seismic categories 1 and 2 structures.

Both codes have been used extensively throughout the nuclear industry and they internationally recognised. The combination of loads used in the design of the Reactor Facility are in accordance with the above mentioned. Code requirements for Nuclear Related Concrete Structures, are identified in Section 4.4.3.1.2.

The IAEA Safety Guide 50-SG-D15 has a requirement for a minimum number of seismic cycles and structural ductility. Stress levels for Operational Basis Earthquake events have been kept in the elastic range to allow for an unrestricted number of cycles and meet the requirements. The structural framework and foundation systems have been designed and checked against extreme events to meet these requirements:

AS 1170 Pt 1 to 4 – Australian Standard Loading Code for seismic category 1, 2 & 3 structures.

AS 3600 - Australian Standard Concrete Structures, used for seismic category 1, 2, & 3 structures.

AS 4100 - Australian Standard Steel Structures Code, used for seismic category 1, 2 & 3 structures.

4.3.3 Design Loads

4.3.3.1 Plant Process Loads:

Plant Process loads include but are not limited to the following types:

Dead loads

Live loads

Pressures such as liquid, atmospheric, gas, soil or rock foundations

Concentrated forces derived from interactions between components and missiles

Thermal

Displacements and volume changes such as concrete shrinkage and creep

Vibration

Dynamic loads such as cask impacts

4.3.3.2 Environmental Loads

Environmental loads include but are not limited to the following:

Earthquake

Wind and associated missiles.

Thermal (derived from environment)

Floods and water penetration

Lighting

4.3.3.3 Other Design Features

Building partitions, layouts, thicknesses, personnel circulation and shielding material comply with Radiation Protection requirements - refer Section 4.4.2 and Chapter 12, Section 12.3

Fire compartmentalisation, fire detection systems and fire suppression systems have been generally used throughout the building to meet the requirements of the Building Code of Australia (BCA) and they are fully integrated into the design of the Reactor Facility - refer Chapter 10, Section 10.2: Fire Protection.

Fire resistance ratings of all materials such as Partitions and Ceilings were selected to meet the requirements of the BCA - refer Section 4.4.2 and Chapter 10, Section 10.2.

Location of corridors and exits between different radiological areas and fire zones are consistent with the emergency evacuation concepts discussed in Section 4.4.2.2 and 11 and Chapter 20.

Corridors, lifts, Safety Access Systems (SAS), room layouts and building exits have been designed to account for personnel circulation with a minimum of disruption consistent with the maintenance of safety standards, material movements and maintenance as detailed in Section 4.4.2.2.

Truck access and craneage has been designed to ensure safe fuel handling, transportation and radioisotope transfer –refer Section 4.4.2.2.4.

Heating Ventilating and Air Conditioning Systems have been fully integrated into the design of the Reactor Facility – refer Chapter 10, Section 10.4

Security and associated systems are as agreed with the Australian Safeguards and Non-Proliferation Office.

Cooling tower and pipework category 2 structural systems – refer to Chapter 6.

End of Section

4.4 REACTOR BUILDING

4.4.1 Design Concept

The features of the Reactor Building include:

- a) The Reactor Building is placed centrally on the site to form a direct physical Entry Building and Auxiliary Services Building thereby allowing the possible future expansion for a second Neutron Guide Hall with offices and laboratories.
- b) The Reactor Building constitutes a series of physical barriers to protect the community, the environment and the facilities in accordance with current design and safety guidelines, regulations, codes and best practice.
- c) The Reactor Building incorporates substantial concrete structures, which act as a shield for the radiation sources within the facility. Much of this shielding takes the form of the reactor block that encloses the Reactor Pool containing the reactor core, the Service Pool, the nitrogen-16 decay tanks and the Control Rod Drive Room. Adjacent to the reactor block are several shielded hot cells and rooms for resin purification. The reactor block and these adjacent structures are built using high-density concrete (i.e., containing special ore aggregates) to enhance their efficiency as radiation shields.
- d) Further measures of protection include segregation of active and non-active areas, separation and segregation of redundant components, as well as strict access control to the containment areas.
- e) A further measure of safety is provided by keeping those zones of the Reactor Building where higher airborne contamination risks are present at a pressure lower than the atmospheric value. This is achieved by the ventilation systems that are described in Chapter 10.
- f) The Reactor Building structure is designed to withstand the effects of dead and live loads, wind, temperature and earthquake.
- g) The dead loads are related to the weights of the building component, fixed plant, equipment and materials. The live loads are related to the personnel and mobile plant and equipment.
- h) Wind gives rise to horizontal pressures and suctions applied to walls, and vertical uplift and downwards pressure on roofs. High winds can also result in impact loads from airborne debris.
- i) Temperature changes give rise to thermal forces generated when elements of the structure are constrained against expansion or contraction. These effects are particularly relevant to the design of the reactor block.
- j) Earthquake or seismic forces, which although of infrequent occurrence, are an important issue in the design of the Reactor Facility. To minimise the possibility of the accidental release of radiation, seismic design criteria have been adopted for the Reactor Building that are well in excess of the requirements of the Australian Earthquake Code AS 1170.4 – 1993. These criteria essentially take the form of two levels of design earthquake event. The Reactor Building structure and its operating systems are designed to survive the lower of the events (Operating Basis Earthquake OBE) without damage. The structure and safety systems must also survive the more severe event (Safe Shutdown Earthquake SSE) without radioactive release of significance to the general public and with the reactor able

to be shut down and the decay heat removed. Re-qualification and some repair works may be required before operation can recommence. Full details of these criteria, and the measures to ensure compliance are given in Sections 4.4.3 of this Report.

- k) The Reactor Building has been designed to withstand the effects of seismic movement by adjacent structures. It has been isolated from unacceptable local loads or failure modes associated with these design earthquakes.
- l) Low probability seismic loads from beyond design basis events for worst case scenarios were considered to ensure ductile behaviour of the structures.

The Reactor Building has been designed to withstand effects of an aircraft. In the event of such an impact the reactor must be able to be shutdown and maintained in a "Safe Shutdown" condition despite damage sustained by the building structure. In order to achieve compliance with this requirement, the upper part of the Reactor Building is surrounded by a grillage of steel beams.

4.4.2 Architectural Design

4.4.2.1 General Considerations

The building's scale is visually reduced by its setting within the topography to minimise visual bulk and optimise on-grade access. The overall design of the complex clearly defines the three major components of the Reactor Building (including Auxiliary Services Building), the Neutron Guide Hall and the Main Entry Building Visitor Centre as an integrated facility.

The Reactor Building itself is a cubic form with a solid concrete wall structure. Exterior openings and feature windows are restricted to the lobby and laboratory facades to optimise outlook and provide a human scale to the otherwise solid enclosure. The extensive concrete surfaces are housed by steelwork structures forming the rooftop aircraft protection and associated wall bracing, and the exposed egress stair. Horizontal grooves to the concrete surface related to pour joints and window sill/head heights are designed to provide further visual relief to the large wall elevations

The extensive concrete wall surfaces are addressed by the following design strategies:

- a) Lightweight steel structures around the wall perimeter to visually lighten the mass – roof grillage for aircraft protection, wall bracing and exposed egress stair.
- b) Horizontal grooves at floor levels, window sill and doorhead levels to articulate the façade.
- c) Roof lanterns to the top of both major staircases to naturally light the extensive stairwells and achieve effective illumination after sunset.
- d) Integration of the support facilities – Neutron Guide Hall, Main Entry and Auxiliary Services Buildings within the foreground to reduce the visual impact of shear walls.

On the basis of the potential for radioactive contamination, parts of the building are deemed to be within the Containment, and as such, are subject to a range of special requirements, including the provision of air-locks and transference rooms with independent ventilation systems having various levels of depressurisation plus special security measures.

High-density concrete and special shielded doors are used as appropriate to ensure shielding requirements.

4.4.2.2 Circulation of Personnel and Equipment

4.4.2.2.1 General Comments

Two major stairs serve the eastern zone containing the majority of the workspaces together with lifts to transverse all floors of the Reactor Building except for Technical Floor and the roof. The northern lift and stair service the operational zones with no contamination potential with access secured at the control room for entry and exit. Movements throughout the operational spaces with some contamination potential have access to the southern stair and goods lift

Separate supplementary stairs are located above and below grade to satisfy egress requirements.

The courtyard building comprising accommodation for administration, health physics, chemistry laboratories, etc, is a one-storey structure on grade for direct access and ease of egress. Vehicular service points are located on grade.

4.4.2.2.2 Principal Movement Routes in Reactor Building

4.4.2.2.2.1 Radioisotope Production Staff

The normal path for radioisotope production staff is by means of the southern Stair.

4.4.2.2.2.2 Bulk Production Radioisotopes

Following irradiation in the tubes of the Reflector Vessel, the irradiation rig is transferred to the Hot Cell where can replacement or unloading tasks may be carried out.

4.4.2.2.2.3 Long Residence Time Facilities Flow Path

Cans are irradiated in the rigs and after the irradiation period are sent to the Hot Cells by means of the Pneumatic Conveyor System. Inside these hot cells there are shielded containers where irradiated cans may be left for short half-life products to decay.

By means of the IPTS, the can is then transferred to the Radioisotope Processing Plant.

4.4.2.2.2.4 Neutron Activation Analysis (NAA)

Neutron activation targets are moved to and from the Reflector Vessel by means of a pneumatic transport system.

4.4.2.2.2.5 Silicon

Fresh silicon ingots are unloaded from a truck in the Truck Access. They are placed on a cart and transferred to an upper level by the Service Lift. They are then stored in the Silicon Pallets Room.

This material is transferred from this storage room to the Reactor Hall by means of Lift No 2 where it is be loaded into the irradiation device.

After the irradiation process, the ingots are removed, and transferred by the reverse process to the Silicon Room where they are etched, cleaned, packed and stored. They are subsequently transferred by Lift No 2 to the Truck Access.

4.4.2.2.3 Equipment Access Routes

4.4.2.2.3.1 Process Maintenance

Pumps and heat exchangers form part of the core cooling system have hoisting devices to enable maintenance to be performed on them. Such maintenance is generally performed in situ with only minor component replacements. If necessary, disassembled components are placed on a cart and taken to the Pump Maintenance Room where maintenance tasks are performed. Discarded components are removed, or new components brought in via the floor hatch in the Reactor Beam Hall floor.

Maintenance within the Sump Room involves work on small pumps, and for this purpose access via the stairs for both personnel and equipment is adequate.

Hoisting devices are provided in the Heavy Water Room to enable the removal of components during maintenance work. These components are moved by trolley to the Pump Maintenance room where they are worked on as required.

4.4.2.2.3.2 Cold Neutron Source

Cold Neutron Source equipment generally has maintenance tasks carried out in-situ. If component removal is necessary, the Reactor Hall overhead crane is used in conjunction with the floor hatch in the corner of the Reactor Hall.

4.4.2.2.3.3 Ventilation Systems

Most maintenance tasks are carried out in-situ. If necessary, components are removed or replaced using carts and the floor hatches to transfer them to or from the appropriate mechanical workshops.

4.4.2.2.3.4 Rigs Maintenance

Rigs are removed from the Service Pool by means of the operation bridge or the Reactor Hall crane and transferred to the Rig Maintenance workshop.

4.4.2.2.4 Fuel Handling

4.4.2.2.4.1 Fresh Fuel

Fresh fuel elements will initially be transported to the Reactor Building within a container on a dedicated truck.

4.4.2.2.4.2 Spent Fuel

A spent fuel element flask will be brought into the Reactor Beam Hall by means of a truck using Truck Access. The truck will be parked beneath the floor hatch and the flask lifted by the Reactor Hall crane and placed on the flask support zone adjacent to the Service Pool. When required, it will be transferred from this position into the Service Pool. The crane will then remove the flask cover and the spent fuel elements will be loaded into the flask. The cover will then be replaced and the flask removed from the Service Pool to be washed and certified clear of contamination. The flask will then be transferred by the reverse process back on to the truck.

4.4.2.3 Emergency Exits

Emergency egress from the Main Entrance Building and the Neutron Guide Hall complies with the "deemed to satisfy" provisions of the Building Code of Australia (BCA).

A number of Emergency egress paths are provided from the Reactor Building at each level. In general, the occupants are provided with a choice of exit and travel distances that meet the "deemed to satisfy" provisions of the BCA, however, a limited number of locations with very low occupancy factors have longer travel distances. In addition, some egress routes require travel to a level above or below before access to an exit is available. The facility is designed to permit unassisted egress of personnel.

4.4.2.4 Radiological Protection

Reactor Building zoning and control points in respect of radiological protection are discussed and illustrated with diagrams in Chapter 12 of this report, along with relevant circulation issues.

4.4.2.5 Security

The security design complies with the requirements of the Australian Safeguards and Non-Proliferation Office (ASNO).

4.4.2.6 Fire

The Reactor Building has been divided into several fire zones separated by appropriate fire barriers. Fire hazards and safety issues are discussed in Chapter 10.

4.4.3 Structural Design

4.4.3.1 Design Criteria

4.4.3.1.1 Load Types

The Reactor Building structure is designed to resist the following types of applied loading:

- a) Gravitational loads:
 - (i) Self weight
 - Superimposed dead loads
 - Live loads
 - general uniformly distributed loads
 - plant and equipment weights
 - crane loads
 - vehicle loads
 - construction loads
 - (ii) Liquid pressure (Reactor Pools, emergency water storage, etc)
 - (iii) Earth and groundwater pressure
- b) Wind loads (generally relevant to external wall and roof areas).
- c) Earthquake loads
 - (i) Operating basis earthquake (OBE)
 - (ii) Safe Shutdown earthquake (SSE)
- d) Aircraft impact
- e) Shrinkage and thermal loading

4.4.3.1.2 Load Combinations

In terms of the categorisation defined in Chapter 2 of this report, the main Reactor Building structure is considered to be "Safety Category 1," and hence the load combinations used in the analysis and design of the structure are those given Nuclear Safety Structures Code. This code was adopted in respect of load combinations because it is the only code that recognises and deals with OBE and SSE seismic load cases and is therefore the internationally accepted best practice code for this application.

4.4.3.2 Evaluation of Loads

4.4.3.2.1 Gravitational including Plant & Equipment

4.4.3.2.1.1 Self Weight

The self weights of building elements are calculated on the basis of the following densities:

Normal weight concrete	25 kNm ⁻³
High density concrete	35 kNm ⁻³
Structural Steel	77 kNm ⁻³
Clay brickwork	22 kNm ⁻³

4.4.3.2.1.2 Superimposed Dead Loads

The floors are designed for the following minimum superimposed dead loads. Higher loads may be used where required for tiled floors, heavier partitions or concentrations of services or where fire-rated ceilings occur.

Floor Finishes	0.5 kPa
Partitions	1.0 kPa
Ceilings and Services	0.6 kPa

The following special superimposed dead loads are also being included in the design loadings where applicable:

Cell Window (Cell Operation,)	50 kN
Cell Windows (Hot Cell Area,)	60 kN for each of 3 windows.
Cell Doors (Hot Cell Area,)	50 kN for each of 3 doors.

4.4.3.2.1.3 Live Loads

The following uniformly distributed live loads have been adopted in compliance with SAA AS 1170.1-1991:

Offices Areas	3.0 kPa
Laboratories	5.0 kPa
NGH Workshop	5.0 kPa + 100 kN concentrated load
Active Workshop concentrated load	10.0 kPa or 7.5 kPa + 40 kN
Storage Rooms	7.5 kPa typical, 5.0 kPa + 100 kN concentrated load

Plant Rooms	7.5 kPa (refer 4.4.3.2.1.4)
Compactus Rooms	10.0 kPa
Reactor Beam Hall	(refer 4.4.3.2.1.4 below)
Neutron Guide Hall	(refer 4.4.3.2.1.4 below)
Cell Operation, Hot Cell Support	110.0 kPa or 7.5 Pa + 40 kN concentrated load
Rig Maintenance	110.0 kPa + 2 x 50 kN concentrated load
Isotope Handling Area	15.0 kPa or 2.5 kN / 10 kN / 40 kN / 100 kN concentrated loads
Neutron Activation Analysis Areas	15.0 kPa / 50kN / 30kN / 10kN
Reactor Pool Hall	15.0 kPa + 250 kN spent fuel casks
Trafficable Roof Structures	
	3.0 kPa
Areas not covered above	4.0 kPa

4.4.3.2.1.4 Plant & Equipment Loads

Plant rooms are designed for the uniformly distributed load given above except where specific items of plant result in a more adverse loading condition.

Dynamic effects where relevant are also included in plant and equipment loadings.

The design of the Reactor Beam Hall floor allows for four (4) research instruments each weighing not more than 500 kN (including shielding) and positioned such that there is a clear spacing of not less than 2.0 m between the heaviest loads. Each instrument has a minimum base contact area of 2.5 m² (200 kPa maximum bearing pressure).

Within the Isotope Handling area the floor under the monorail is designed for a 100 kN concentrated load for the isotope cask. The loading includes an additional dynamic component for the cask being placed on the floor

In the Reactor Hall the area between the cask support zone and the access hatch is designed for a 250 kN concentrated load for the spent fuel cask. This loading includes an additional dynamic component for the cask being placed on the floor

4.4.3.2.1.5 Crane Loadings

The structure of the Reactor Building is designed for the loads applied by the following cranes:

- SWL gantry crane above the Reactor Beam Hall.
- SWL gantry crane above the Reactor Hall.
- SWL monorail crane above the Isotope Handling Area (Radioisotope Cask Hoist)).

Crane loads applied to the building structure are calculated in accordance with AS-1418 Crane & Hoist Code.

4.4.3.2.1.6 Vehicle Loads

The truck loading bays are designed for wheel loads derived in accordance with the Austroads Bridge Code 1992.

4.4.3.2.1.7 Construction Loads

Construction loadings generally do not govern the design of structural elements. Nevertheless, careful consideration was given to construction procedures and sequences during the Detailed Engineering stage in order to identify any situations where a construction case could govern the design of any part of the structure. Such loadings have been clearly identified and scheduled on the detailed engineering structural drawings.

4.4.3.2.2 Wind Loads

The Reactor Building is designed for wind loads determined in accordance with AS-1170.2-1989 "SAA Loading Code Part 2: Wind Loads" with the following parameters:

Structure Importance Multiplier	1.1
Structure Shielding Multiplier	1.0
Terrain Category (AS-1170.2 Clause 3.2.4)	2.5
Region (AS-1170.2 Clause 3.2.2)	A

Wind Speeds

Basic wind speed for ultimate strength limit state	$V_u = 61$ m/s
Basic wind speed for permissible stress methods	$V_p = 50$ m/s
Basic wind speed for serviceability limit state	$V_s = 38$ m/s

(In this instance V_u and V_p are calculated using Clause E3.2.2 of the Code based on a 5% probability of the wind speed being exceeded in a 2000 year period. These criteria exceed the maximum wind speed V_u of 55 m/s implied by a 1.1 importance factor.)

4.4.3.2.3 Earthquake Loads

As previously stated in Section 4.4.1 of this Report, the Reactor Building structure is designed to survive an extreme (return period) seismic event known as the Operating Basis Earthquake (OBE), without structural damage. The structure must also survive an extremely rare (very long return period) seismic event, known as the Safe Shutdown Earthquake (SSE), to the extent that there is no unacceptable release of radiation, and that the reactor can be shut down and the decay heat removed. In this latter event it is likely that some repair works would be required before operation could resume.

Ground motions applicable to each of these seismic events are as follows:

a) **Operating Basis Earthquake**

This is nominally regarded as a seismic event with a return period that is related to the operating life of the facility. Based on results of seismic hazard studies for the ANSTO RRRP, a horizontal response spectrum has been adopted with a peak ground acceleration (PGA) of 0.09 g and a peak spectral acceleration of 0.32 g.

The adopted spectrum for the SL-1 corresponds to the one of the US NRC Regulatory Guide 1.60 scaled to 0.09g

b) **Safe Shutdown Earthquake**

This is nominally regarded as a seismic event with a return period of 10,000 years. This spectrum has a PGA of 0.37 g and a peak spectral acceleration of 0.82 g.

As for the OBE, a uniform risk horizontal acceleration spectrum has been adopted.

The adopted SL-2 spectrum corresponds to the bounding curve for the IGNS with PGA 0.37g and the US NRC Regulatory Guide 1.60 scaled to 0.30g

Note that the vertical response spectra for the OBE and SSE are obtained by scaling the corresponding horizontal response spectra by a factor of 2/3.

Details of the modelling and analysis approach used in respect of earthquake loadings, as well as the derived floor response spectra, etc. are given in Section 4.4.3.3.2.4 of this Chapter.

4.4.3.2.3.1 Fire Report on Impact

The site is remote from Bankstown and Kingsford Smith airports in the Sydney basin as detailed in Chapter 3 and the impact design does not directly associate with landing or take off phases. The aircraft may be assumed to be late ascent, early descent or cruising modes.

The mechanical impact details are in this Chapter and the related fire threat is considered in a separate reference as a bounding case for fire. This reference shows that the fire generated from the aviation fuel is expected to last for 20 minutes and that is far less than the specified ratings for Reactor's roofs and walls. The associated temperature rise in the reinforcement and minor spalling has also been shown to be acceptable. These criteria, base data, design details and comparisons to prove compliance are included in the reference.

4.4.3.2.4 Temperature and Shrinkage

For the various components of the concrete structure of the Reactor Building, other than the reactor block itself, stresses resulting from concrete shrinkage and thermal forces are catered for.

The design of the reactor block however has necessitated detailed consideration of the stresses due to the temperature gradient resulting from dissipation of the heat generated in the Reactor Pool at the core level. Because of its massive nature, shrinkage of the concrete in the reactor block needed to be controlled.

Properties of the high-density concrete which constitutes the bulk of the reactor block are dealt with in Section 4.4.3.5 of this report. The desirable properties of this concrete, apart from strength, durability and shielding capability, are high thermal conductivity (to minimise high local thermal gradient), low coefficient of thermal expansion (to minimise temperature stresses) and a low drying shrinkage (to minimise shrinkage cracking).

The shrinkage strain to be resisted in addition to thermal forces was taken as 0.00015. This strain criterion has been previously applied on similar works and found to provide acceptable performance.

4.4.3.2.5 Serviceability Criteria

4.4.3.2.5.1 Design Life/Durability

Concrete elements of the main Reactor Building have been designed for a minimum life of 70 years. The administration and laboratory area and other ancillary components of the Reactor Building that are not part of the containment have been designed for a minimum life of 55 years.

Above-ground exterior concrete surfaces have concrete covers to reinforcement in accordance with AS 3600-1994 for exposure classification B1. All concrete in the Reactor Building structure has a concrete strength not less than 32 MPa.

4.4.3.2.5.2 Maintenance and Life Cycle Costs

Materials and coatings have been selected to minimise (consistent with other design requirements) maintenance work and hence life cycle costs. Floors subject to decontamination or exposure to chemicals have an applied protective epoxy surface both for ease of cleaning and to ensure durability.

4.4.3.2.5.3 Deflection Criteria

Maximum deflections under service load conditions based on recommendations given in AS 3600-1994 for concrete beams and slabs and for the composite steel girders are as follows:

Generally	Span/300
Incremental deflection under masonry partitions	Span/1000 (or Span/500 where movement joints are provided)
Incremental deflection due to compactus loads	Span/1000

The Reactor Beam Hall floor is designed to comply with specific deflection criteria in order to ensure the proper operation of instruments located on this floor Under the combined incremental effect of the weight of the instrument, other specified live loads, vibrations from other plant, concrete creep and foundation settlement. In respect of the two latter effects, allowance has been made for 10 years of operation before adjustment of the beam lines may be required. These criteria governed the design of the Reactor Beam Hall slabs and supporting columns.

4.4.3.2.5.4 Impermeability

The water storage tanks, the below-ground perimeter walls and the internal basement slabs on ground are all designed to comply with AS 3735-1991 "Concrete Structures for Retaining Liquids" in order to minimise the risk of moisture penetration. Special attention has been paid to compaction of this concrete and the provision of waterstops, etc, at construction joints. Concrete mixes for these elements were designed for a shrinkage of 500 microstrain (at 56 days).

Leakage from within the building into the surrounding soil is prevented by means of the following measures:

- Liquid waste is collected in tanks located at the basement. These tanks have a clearance below them that enables any leakage to be detected visually.
- There are liquid collection points at key locations throughout the facility that will collect any potential leakage from the various water handling systems. The collected water is routed via a pipe network to the sump tanks. (Refer to details of the waste management system presented in Chapter 12.)
- There is a leak detection network that covers the Reactor and Service Pools and all pipes connecting to them.
- The floor is provided with an epoxy-coated surface to prevent possible ingress of liquid into and through the slabs.

- e) Post pour cracking in the basement has been repaired with a xypex based solution to an approved procedure.

4.4.3.2.5.5 Radiation Shielding

High-density concrete (3500 kg/m³) and/or normal concrete walls and slabs are used as required throughout the structure to provide radiation shielding. Details of general and specific criteria in respect of radiation shielding are given in Chapter 12 of this report.

4.4.3.3 Analysis and Design

4.4.3.3.1 General

4.4.3.3.1.1 Footings

The main body of the Reactor Building is founded the existing surface level. On the basis of the geotechnical investigations carried out (Coffey Geosciences Report No. S20251/1-BB November 1999), the footings were designed as strips and pads integral with the Floor Slabs founded on Class III / II sandstone. The sandstone at this depth is moderately to slightly weathered and generally relatively massive in character. Coffeys nominated a maximum allowable bearing pressure in this material of 6000 kPa, subject to settlement criteria and in-situ testing.

Footing design loads were assessed on the basis of gravity load run downs and the seismic analysis results (refer Section 4.4.3.2.2). Most of the low-level Reactor Building footings had their sizes governed by settlement limits arising from the stringent deflection criteria applicable to the Reactor Beam Hall floor rather than the bearing pressure referred to above. In this regard, the footings and rock foundation were modelled and analysed using the SAP 2000NL finite element program to determine deflections of the Reactor Beam Hall floor (refer to 4.4.3.3.2.3 for description of SAP 2000NL).

Rock anchors are in place to hold the Reactor Building base slab down under earthquake loading. The pull-out capacity of the rock anchors has been calculated using the rock shaft adhesion parameters nominated in Coffey's report.

4.4.3.3.1.2 Water Storage Tanks

The reinforced concrete walls and floors of the LOCA pool and the heavy water recess are integral with the footings. They are designed to resist appropriate combinations of internal and external hydrostatic pressures. To ensure adequate water-tightness, the pools have been designed to comply with AS 3735-1991 "Concrete Structures for Retaining Liquids", in addition to ACI-318.

4.4.3.3.1.3 Columns

Column loadings are assessed with the aid of EXCEL spreadsheets and independently verified in-house by a senior experienced engineer.

Columns supporting the Reactor Beam Hall floor are modelled together with the Beam Hall Level floor and the footings by the SAP 2000NL finite element program in order to accurately determine the deflections under the instruments operating on the Hall floor. The stringent floor deflection criteria governed the sizes of these columns.

4.4.3.3.1.4 Walls

The reinforced concrete shear walls of the Reactor Building are designed principally for the in-plane seismic loadings obtained from the SAP 2000NL finite element analysis (see

Section 4.4.3.2.3). Out-of-plane seismic loading and wind pressure loading are also investigated.

Requirements in respect of minimum reinforcement ratios, and maximum bar diameters and spacings, are complied with to control cracking due to shrinkage and thermal stresses.

Perimeter walls below ground level are designed to resist "at rest" earth pressures in accordance with geotechnical recommendations ($K_0 = 0.46$), and also for a potential build up of groundwater.. In this respect the requirements of AS 3735-1991 "Concrete Structures for Retaining Liquids" are also observed.

4.4.3.3.1.5 Floors

The analysis methods adopted for the various floor areas and panels depends on the size and complexity of the floor framing, the nature of the loadings and the other design criteria for the given area.

For the simpler and more straight-forward situations, the slabs and beams are analysed and designed for compliance with the respective codes. Where the interaction with integral walls, columns and adjacent floors warrants more accurate modelling, or the loadings are large and more complex in their distribution, floors are analysed and designed with the aid of RAPT concrete design software. RAPT has the ability to design slabs and beams to the required codes including AS 3600.

As stated previously, the Reactor Beam Hall floor was modelled and analysed by the SAP 2000NL finite element program to accurately determine the deflections under the instruments operating on the Hall floor and thereby to ensure that the stringent deflection criteria were not exceeded.

Note also floors in contact with the ground are integral with the reinforced concrete walls and had to be analysed and designed for hydrostatic pressure allowing for possible groundwater build up. . As for the perimeter walls at this level, the provisions of AS 3735-1991 were applied to ensure water-tightness.

4.4.3.3.1.6 Roof

Roof slabs and beams are designed in accordance with the principles outlined above, except that aircraft impact load conditions govern much of the design. Aircraft Impact Grillage

Principles adopted for the analysis and design of this structure are described in Section 4.4.3.2.4.

4.4.3.3.1.7 Reactor Block

The Reactor Block is analysed for both seismic and thermal load effects on a finite element basis using SAP 2000. Various layers of reinforcement are used throughout the massive structure to appropriately resist internal stresses. Further details are given in Sections 4.4.3.2.2 and 4.4.3.2.4.

4.4.3.3.2 Seismic

4.4.3.3.2.1 Modelling

General

3D mathematical modelling of the Reactor Building structure has been carried out incorporating all principal structural members of the building's framing system and the

secondary elements that participate in resisting horizontal and/or vertical seismic loads. They include reinforced concrete walls, main columns, beams, high-density reinforced concrete structures, and floor diaphragms

While all structural steel members are modelled using conventional beam elements, concrete structures are modelled using a range of finite elements including beam, membrane (rigid or flexible), panel (plane-stress), plate, shell and brick elements. This is described in detail in the following section.

Concrete Elements

All concrete columns and (internal, edge and coupling) beams are modelled using 3D beam elements with appropriate flexural and shear terms. Material and cross-sectional properties of these beam elements should represent the actual stiffness and mass properties of the concrete members.

The adopted cross-section area and the moment of inertia of the beam elements reflect the level of cracking of the concrete member they are modelling under the combination of gravity and seismic loads.

Reinforced concrete walls were modelled with panel and/or plate elements with appropriate mass densities. This allowed correct representation of mass and stiffness of walls as well as accurate modelling of all major penetrations and openings in the walls.

Where appropriate, volumes of concrete in the structure were modelled with "brick" finite elements. For example, the heavy concrete of the Reactor Block was modelled using brick elements. This allowed the complex geometry of the Reactor Block to be accurately modelled, and the stresses due to gravity and seismic loads to be accurately analysed.

Reinforced concrete floors at each level may be regarded as rigid diaphragms able to transmit induced lateral seismic loads to shear walls and other lateral load resisting systems. Deformations perpendicular to the plane of the diaphragm are modelled so as to enable determination of vertical floor response spectra with the SAP 2000 NL models.

Seismic Mass

Wherever appropriate, the masses of the structural elements themselves were explicitly modelled by associating a smeared density to those elements. Other masses (and mass moments of inertia) associated with super-imposed dead/live load and seismic live load were lumped at their centre of mass on each floor and incorporated into the diaphragm.

Seismic mass for the building was calculated based on the seismic weight obtained using the approach described in this section. This approach is consistent with the recommendations of IAEA TEC DOC-348.

The seismic weight at each level was taken as the sum of dead loads and seismic live loads between the mid-heights of adjacent levels. Dead loads included self-weight of the building plus superimposed dead loads including installed equipment and distribution systems at their maximum normal operating weight. Water movement effects were also considered. The weight of the water in the Reactor Pool was also considered as dead load. In some models the weights of the walls were distributed between floor levels and not lumped at floor levels in the manner described above. This enabled the determination of the out of plane loading imposed on the walls, in particular in those regions where there are large voids within the building.

Seismic live loads were taken as a proportion of the design live load as follows.

The percentages of live load given have been assessed on the basis of the actual average live loads that would normally be on the floors in service.

Rock-Structure Interaction

The effect of rock-structure interaction is included in the seismic analysis of the Reactor Building structure.

For seismic analysis, the Reactor Building is modelled as being supported on the rock at foundation level without lateral support from adjacent soil or rock between foundation and ground levels. The resulting seismic stresses and deformations calculated on this basis are conservative. Consistent with this approach, the design response spectrum is applied at the foundation level.

The interaction between the structure and the foundation is modelled by the insertion of springs between the structure and the reference surface. These springs are derived on the basis of a modulus of subgrade reaction approach and considerations of an infinitely stiff structure on an elastic half-space. The individual springs are not able to provide an exact match for the rocking and vertical stiffness. Accordingly it is necessary to have separate models for vertical and horizontal response spectra determination.

The Geotechnical Consultant for the project, Coffey Geotechnical Services, advised in correspondence of 29 November 2000 that rock vertical stiffness would be between 360 kPa mm^{-1} and 720 kPa mm^{-1} with a recommended design value of 480 kPa mm^{-1} .

4.4.3.3.2 Analytical Methods

Response Spectrum analysis

A three dimensional response spectrum method of seismic analysis has been used for all Category 1 and 2 buildings including the Reactor Building under the OBE and the SSE.

In this method, an eigen-value analysis of the structure was initially carried out from which natural frequencies of vibration and the corresponding mode shapes of the structure were extracted. A transformation of coordinates was then carried out which allowed the seismic response of the global structure to be described by the superposition of its (single degree of freedom) modal responses. This is often referred to as the modal superposition technique.

For an adequately accurate modal superposition, the first 20 natural modes of vibration of the structure were considered. The number of modes was selected in order to ensure that not less than 90% of the building mass participated in the direction under consideration.

The models that had significantly dispersed masses, rather than lumped at the individual floors, had a large number of mass degrees of freedom. For the response spectrum analysis of these models, Ritz vectors were used instead of the natural vibratory mode shapes in order to efficiently accumulate an adequate representation of the total mass of the structure.

The modal response spectrum method of analysis makes direct use of appropriately damped OBE and SSE response spectra. Using these spectra, the peak seismic response of the modes of vibration of the structure was obtained knowing the natural period of each mode.

To account for the fact that the peaks of all modal responses do not occur simultaneously, a Complete Quadratic Combination (CQC) technique was used to combine the modal peak responses and obtain the overall peak response of the structure.

Elastic Time History Analysis

Although a response spectrum analysis procedure as described above is adequate for global seismic analysis of the Reactor Building, such a procedure is incapable of providing floor spectra at the various levels of the Reactor Building as required by the equipment designers. Therefore, elastic time history analyses were performed instead under the OBE and the site-specific SSE to produce floor response spectra at various levels of the Reactor Building.

Time-histories of ground motions for the OBE and SSE were required in order to undertake a time-history analysis of the Reactor Building structure. In order to cover a wide range of frequency content, three statistically independent sets of ground motion time-histories were developed synthetically using the OBE and SSE design spectra (Figure 4.4/15) and appropriate duration envelope functions for the OBE and SSE events.

4.4.3.3.2.3 Analytical Tools

Depending on the design phase one of the following computer analysis programs was used:

ETABS7

At the preliminary design phase, ETABS7 was used for equivalent static and response spectrum seismic analyses of the concrete framing (i.e., incorporating walls, beam/column framing, concrete floor diaphragms) to evaluate earthquake induced member design actions and input forces for foundation analyses.

SAP2000NL

SAP 2000NL was used in the detailed design phase for analysing and confirming the design of the Reactor Building. Three dimensional modal response spectrum analyses were undertaken to evaluate earthquake induced internal forces for member design, lateral storey displacements, storey shears, storey overturning moments etc, as well as input actions for foundation analyses. Boundary conditions were appropriately modelled to simulate expected soil structure interaction.

Elastic time history analyses were performed to develop floor spectra.

The in-built concrete design modules of SAP2000NL were also used for design of concrete structures according to ACI 318-1995.

(Note that both SAP and ETABS are commercially available and internationally recognised structural analysis programs that have been developed and upgraded over many years - the original version of SAP was released in 1970. They are used by over 6000 firms and government agencies in about 90 countries. Verification manuals are provided with both the ETABS7 and SAP2000 software.)

Other Programs

Independent verification of the seismic design has been carried out by using a common model and other general purpose high end finite element programs such as;

NISAI as distributed by Engineering Mechanics Research corporation (EMRC) and ABAQUS as distributed by Hibbit, Karlsson and Sorensen, Inc (HKS).

ABAQUS has particular strength in the area of non-linear transient analysis utilising concrete cracking models.

4.4.3.3.2.4 Summary of Analysis Outputs

ETABS Outputs

Two load cases were analysed using the ETABS model. The first case in the east west direction and the second in the north south direction.

A summary of the shear force at each floor level, the distribution of shear force to the major shear walls and the deflections are given below for the two load cases.

Load Case 1 – Earthquake in East/West Direction (SSE)

The results of Load Case 1 covering an earthquake in the east/west direction are presented in Table 4.4/2.

The distribution of shear force to wall RW1 is reduced by the large window and door penetrations to the Neutron Guide Hall. The corresponding increase in the loading on the reactor block between these floors is due to the redistribution of load from wall RW1.

Between the Reactor Hall floor and the roof the walls along grids P and R contribute to the shear restraint of the building.

Load Case 2 – Earthquake in North/South Direction (SSE)

The results of Load Case 2 covering an earthquake in the north/south direction are presented in Table 4.4/3.

Between the Basement floor and the floor of the Beam Hall there are additional walls in the north-south direction that contribute to the shear restraint of the building.

Mode Shapes and Effective Modal Masses

Global dynamic response of the reactor building structure, which is a result of the modal response spectrum analysis, is shown in Table 4.4/4. The results include:

- a) Natural frequencies (eigenvalues) and effective modal masses.

The first twenty natural modes of vibration have been considered. The total number of modes considered in the analysis corresponds to the mass participation of 90%. In the following table the modal masses are expressed as a percentage of the total building mass.

- b) Natural Frequencies and effective modal masses:
- c) Mode shapes (eigenvectors):

The significant mode shapes, i.e. mode shapes with significant modal mass input, are presented.

The effective modal mass is presented as a percentage of the total mass. Refer to Figure 4.4/14.

Floor Response Spectra

In order to evaluate floor response spectra for the design of secondary systems, including floor-mounted equipment, a three-dimensional finite element model of the Reactor Building has been generated using the SAP 2000NL program.

This model has been subjected to suitable time histories of ground motion. Linear time history dynamic analysis have then been carried out to obtain response spectra at various levels of the reactor building. These floor spectra include two horizontal components [along east–west (X) and north–south (Y) axes] and one vertical (Z) component.

The synthetic ground motion time histories were derived using the computer program SIMQKE, which assumes that any periodic function can be expanded into a series of sinusoidal functions with different amplitudes and phase angles. These time histories of ground motion can be termed “synthetic” as their frequency contents have been altered.

As all three components of so produced synthetic time histories are statistically dependent (they are based on the same frequency content), they have been applied individually. The floor response spectra were obtained by combining the co-directional spectral amplitudes from three individual analyses using the SRSS rule (Square Root of the Sum of the Squares).

The results presented herein are based on dynamic analysis under synthetic time histories.

The Floor Response Spectrum has been developed for each of the two orthogonal horizontal directions and the vertical direction.

A typical output of the time history analysis for the Synthetic Design EQ at the Technical floor Level is presented below.

Figure 4.4/15A shows the Floor Response Spectrum for the horizontal direction Y (N–S).

Figure 4.4/15B shows the Floor Response Spectrum for the vertical direction Z.

The Floor Response Spectrum obtained from the time history analysis has been smoothed and broadened. This process takes into account the variations in the structural frequencies due to the potential for difference in the behaviour of the actual structure compared to the finite element model.

The spectrum peak broadening was done using one of the methods outlined in ASCE. The adopted method allows for normal uncertainties in the derivation of floor spectra, including assumptions made in modelling the structure and rock-structure interaction.

As the sensitivity study of the individual parameters that affect the frequencies of the reactor building structure was not performed, a minimum broadening value at each frequency was adopted in accordance with the code method. Because considerable conservatism is introduced within this broadened peak region, a reduction in the peak amplitude is used in conjunction with the spectral broadening. This reduction is permissible provided that the equipment damping is less than 10%.

The final Floor Response Spectrum, which is used for the design of equipment, is constructed as an envelope to the above explained spectrum peaks.

This is performed for each spatial component of the response spectra.

Figure 4.4/15C shows the typical Design Floor Response Spectrum for the horizontal direction X at Technical Floor Level at the location shown on the floor layout (refer Fig 4.10).

Similarly, using the method explained above, the Design Floor Spectra Curves could be supplied for any location at any level of the Reactor Building as requested by the designer of equipment.

For the purpose of equipment design, a series of the Design Floor Spectrum curves are presented below:

Figure 4.4/15D shows horizontal and vertical components of the Design Floor Response Spectrum for the Basement Level.

Figure 4.4/15E shows horizontal and vertical components of the Design Floor Response Spectrum for Beam Hall Level.

Figure 4.4/15F shows horizontal and vertical components of the Design Floor Response Spectrum for Main Entrance Level.

Figure 4.4/15G shows horizontal and vertical components of the Design Floor Response Spectrum for Technical Offices Level.

Figure 4.4/15H shows horizontal and vertical components of the Design Floor Response Spectrum for Reactor Hall Level.

Figure 4.4/15I shows horizontal and vertical components of the Design Floor Response Spectrum for Emergency Make-up Water Tank Level.

The locations for which these Design Floor Spectra have been determined are shown on the floor layouts.

From inspection of horizontal floor spectra curves, the spectral acceleration values are generally higher at upper floor levels indicating greater amplifications at these levels. This is consistent with the response of multi-storey buildings.

The vertical floor spectra curves, however, do not necessarily follow this pattern as they are more influenced by the flexural behaviour of the floor and the location of sampling point along the span than by the level of the floor within the building.

This effect is illustrated by comparing vertical spectral values at Technical Offices Level and Reactor Hall Level.

The sampling location at Technical Offices Level occurs in the middle of a relatively long floor span. This leads to higher vertical spectral values compared with Reactor Hall Level, even though the Reactor Hall is a higher level in the building.

4.4.3.3.2.5 Design of Primary Elements Subject to Seismic Loads

Reactor Block

The primary function of the reactor block is to provide structural support and radiation shielding to the Reactor and Service Pools. The reactor block is constructed out of high-density concrete to achieve this.

The reactor block forms a very stiff element in the reactor building structure as a result of the very thick walls required for the radiation shielding and carries up to 40% of the seismic loadings on the Reactor Building.

The reactor block needs to be accurately modelled in the seismic analyses in order to determine the extent of the seismic load it will attract and the resultant stresses that will be induced in the concrete from these loadings. The reactor block was modelled using block elements in the SAP2000 NL finite element program to establish these load distributions.

The reinforcement for the reactor block has been designed on the basis of the results of these final analyses and the requirements for crack control due to shrinkage of the concrete from heat of hydration.

Concrete Walls

The concrete walls provide the majority of the seismic bracing for the Reactor Building. As noted above, the remaining bracing is provided by the reactor block.

The Reactor Building was modelled using the ETABS program to establish a preliminary distribution of the seismic loadings to the concrete walls. A more detailed analysis was then undertaken using the SAP2000 NL program to model the building. Each of the concrete walls and floors was modelled using a mesh of plate elements. This allowed

detailing of the reinforcement in the walls to ensure sufficient reinforcement was provided in these areas of high stress concentration for the strength and ductility of the walls.

The following seismic loadings were considered for the wall design.

- Ultimate dead and live loads with a vertical OBE event.
- Ultimate dead and live load with a horizontal OBE parallel to the wall.
- Ultimate dead and live load with a horizontal OBE perpendicular to the wall.
- Working dead and live load with a horizontal SSE parallel to the wall.
- Working dead and live load with a horizontal SSE perpendicular to the wall.

Generally the horizontal SSE parallel to the wall governed the design of the walls due to the relatively small dead and live loads on the walls and the high shear and axial forces that would be generated from the earthquake.

Floor Diaphragms

The floor diaphragms were designed using the same analyses as the concrete walls. The forces in the floors obtained from the final SAP 2000 NL analyses were reviewed and any additional reinforcement required for the floor slabs and beams added to account for the vertical seismic component in the relevant design load combinations.

Aircraft Impact Steel Grillage

The aircraft impact grillage was modelled using the finite element analysis program STRAND7. This software enabled the analysis of steel structures where non-linear stress-strain relationships for the material properties or plate elements were required.

The peak response of the building at the support points for the grillage was obtained from the SAP2000 analysis and used in the STRAND7 analysis to determine the forces induced in the grillage from the OBE and SSE events. These forces were then included in the appropriate load combinations in AS1170.1 Loading Code for the design of the grillage to AS4100 Steel Structures Code.

Earthquake loadings do not govern the design of the grillage as the plane impact loads are very large compared to the weight of the steel grillage.

Footings

The footings for the reactor building are incorporated into the Basement and Sub-basement floor slabs as the slabs are founded on rock with safe bearing capacities in the order of 3000 MPa.

The footings have been designed from the loadings obtained for the SAP2000 model.

The major issue with the seismic loadings on the design of the footings is the restraint of uplift under the concrete walls. Lift-off of the base slab from the rock foundation is prevented in order to avoid damage to the base slabs during an earthquake event from the redistribution of these uplift forces to other more heavily loaded areas of the building.

Lift-off is prevented by the use of standard reinforcing bars grouted into holes bored into the rock foundation.

The reactor block base slab acts as a monolithic element and, as a result, is capable of redistributing uplift forces to more heavily loaded walls during the design earthquake event without exceeding its design capacity. For this reason rock anchors were not required to restrain the reactor block walls in the way that they were required for the concrete shear walls in the building.

Seismic Overload on the Structure

The reactor building has been designed to remain elastic for loadings up to and including the SSE event. Because the structure is detailed to behave in a ductile manner and because all elements are not loaded to their maximum capacity under the SSE event, the reactor building has reserve strength to survive earthquakes larger than the SSE event.

In achieving its maximum resistance under larger earthquakes, the structure would be stressed beyond its elastic limit. This would result in increased deflections compared to the current elastic design for the SSE event. It would also result in cracking of concrete and yielding of steel reinforcement in highly loaded members.

Work was carried out to assess the approximate reserve strength capacity of the reactor building using the results of the analyses for the SSE event. A summary of the findings from this assessment is given below.

The assessment of an earthquake in the east-west direction indicated that the north and south perimeter walls of the building and the reactor block would fail in shear at a loading approximately twice the SSE loading with no lateral support assumed to be available from the 9 metres of rock in the surrounding excavation.

The assessment of an earthquake in the north-south direction indicated that some of the internal cross walls would fail in shear at loadings at loading approximately 20% above the SSE loading but the main perimeter walls and the reactor block would not fail until a loading approximately twice the SSE loading.

In summary, the assessment based on elastic analysis results, indicated that the reactor building would be expected to survive seismic loadings much higher than the SSE loadings, but with loss of some minor shear walls, substantial deflections, concrete cracking and yielding of reinforcement. The safety factor is expected to be two. A factor of two implies that earthquakes with similar ground motion characteristics to the adopted design SSE with a PGA of up to 0.6 g can be accommodated while safely shutting down the reactor.

Additional investigations are being carried out on the building anchorage behaviour, rock interaction, pool liner performance, realistic material strength and feasible extent of useful optimisation. This work will give greater precision to the expected performance of the facility for low probability extreme event scenarios.

4.4.3.3.3 Aircraft Impact

4.4.3.3.3.1 Design Principles

An additional layer of protection is provided in the form of an Aircraft Impact Steel Framed Grillage (AISFG) over and around the relevant part of the building structure..

The AISFG structure is clear of the upper roof structure, to permit substantial energy absorption by elastic and plastic deformation.

The bulk of the aircraft kinetic energy will be absorbed by deformation of the grillage and crushing of the aircraft structure. It is possible, however, that parts of the aircraft (principally the engine) will break off and pass through the grillage with very little reduction in velocity and proceed to impact the roof structure

4.4.3.3.3.2 Design Methodology

General

The design methodology adopted for aircraft impact follows the principles outlined in the US Department of Energy Standard.

Three types of analysis have been utilised and these are summarised as follows:

- Equivalent Static Analysis (Energy Balance Method)
- Transient Dynamic Analysis (Missile - Target Interaction Analysis Method)
- Time-History Analysis (Force Time-History Analysis Method)

The above descriptions shown in parentheses are the terms used in the DOE standard.

The three types of analyses are described in more detail in the following sections.

Aircraft Impact Steel Framed Grillage (AISFG)

The following design methodology is used to undertake the design for aircraft impact on the AISFG:

- a) The AISFG is designed to withstand the direct impact from the design aircraft.
- b) A design criterion is that the AISFG structure can experience local damage due to impact but its global integrity and stability shall be maintained.

Equivalent Static Analysis

For concept analysis of the AISFG, an equivalent static analysis was carried out, based on the principles of conservation of momentum and energy considerations.

Transient Dynamic Analysis

Following the preliminary static analysis of the AISFG using the principles of momentum and energy, more accurate transient dynamic analysis has been carried out.

This method of analysis, also referred to as a "flying mass analysis" uses finite element analysis software to simulate the impact of an aircraft on the AISFG.

The aircraft is modelled as a mass or structure impacting at specified points on the AISFG at a predetermined velocity.

The computer software calculates the resulting effects on the AISFG structure as a function of time during the impact. Such effects include deflections, forces, stresses, strains and strain energy absorbed.

Because the flying mass analysis simulates an aircraft impact, the principles of conservation of momentum and energy are satisfied automatically, and do not need explicit calculation.

The flying mass analysis has been used to check vertical and horizontal aircraft impact at several locations on the AISFG.

Time History Analysis

To check the results of the transient dynamic analysis, time history analysis has also been carried out utilising the Force v Time relationship.

In this method, the Force v Time relationship is used as an input "forcing function" to the time history analysis. The computer output provides results of the type referred to under "Transient Dynamic Analysis", i.e. deflections, forces, etc as a function of time.

At this stage, time history analysis has been utilised for vertical aircraft impact at the centre of the AISFG.

Reactor Hall Roof (Upper Roof)

The following design methodology was used to undertake the design for aircraft impact on the upper roof structure over the Reactor Hall.

The horizontal elements (slabs) of the Reactor Hall roof act compositely with closely spaced structural steel roof beams.

A permanent steel formwork is used to form the roof slabs and to provide additional resistance to scabbing of the inner concrete surface under the design rigid missile impact load.

The vertical elements (walls around the raised section of roof) of the Reactor Hall roof are reinforced concrete walls. These walls are sized to withstand the design rigid missile impact load without perforation.

4.4.3.3.3 Modelling and Analysis

Modelling

The Aircraft Impact Steel Framed Grillage (AISFG) is modelled in three dimensions using STRAND7, a finite element analysis program. This program can model the grillage in the elastic and plastic state.

The location of the aircraft impact is varied over the grillage surface to determine the worst load case for the individual grillage elements and for the grillage reactions to the supporting structure.

Modelling done to this stage has been based on "beam" or "line" elements. Where symmetry permits, quarter or half models have been used for the transient dynamic analysis ("flying mass") and time history analysis.

Impact Locations

The equivalent static analysis was carried out for the case of vertical aircraft impact at the centre of the AISFG.

In the case of the transient dynamic ("flying mass") analysis, several impact locations have been considered.

The time history analysis has been carried out for vertical central impact only, as a check on the corresponding flying mass analysis.

Analytical Method and Tools

STRAND 7 is the finite element analysis software package that has been used for the analysis and design of the AISFG, its supporting structure, and the upper roof and walls to the Reactor Hall.

STRAND7 has been used for the equivalent static, transient dynamic ("flying mass") and time history analyses of aircraft impact. Such analyses have generally been carried out as non-linear analyses, allowing for plasticity.

Stress-strain relationships for the various structural steel members have been input into STRAND7, based on typical material stress-strain curves for Australian steel.

4.4.3.3.3.4 Analysis Outputs

The analysis results demonstrate that the AISFG can satisfactorily absorb the kinetic energy of the postulated aircraft impact.

The detailed design has included the investigation of smaller members, more closely spaced, and of various section types - eg tubular, plate and "H" sections.

The detailed design work has also included the "linking" of the AISFG model to the model of the Reactor Building Upper Roof to allow for sharing of aircraft impact between the AISFG and the Upper Roof Slab. Such "linking" has been simulated in the computer analysis so the load would be taken on the roof slab after the AISFG deflects sufficiently to impinge on the Upper Roof.

4.4.3.3.3.5 Design of Principal Elements

AISFG

The steel members and connections for the AISFG have been designed to provide the structural strength and ductility required by the computer analysis results.

AISFG Supports and effects on Reactor Block.

The aircraft impact steel framed grillage (AISFG) is anchored on concrete columns at each corner of the frame by baseplate and holding down bolt assemblies. The concrete columns are founded on rock. Steel columns transfer the loads. The vertical loads are transferred down these columns whilst the horizontal loads are transferred into the building structure.

The reactor block and the building structure in general have sufficient capacity to resist the aircraft impact as the aircraft impact loading is significantly less than the design seismic load which dictated the design of the buildings bracing system.

Composite Roof Structure

Under an aircraft impact event, the roof slab is designed to resist the full energy of the design rigid missile or a portion of the energy from the design non-rigid missile with the remainder being dispersed in the AISFG.

The concrete roof slab thickness is the thickness required to resist perforation of the slab by the design rigid missile.

Scabbing of the concrete from the underside of the roof slab due to aircraft impact must be contained as the slab spans directly over the top of the Reactor Pool.

Walls around Upper Roof Area

The concrete walls between the main reactor hall roof and the upper reactor hall roof are cast-in situ reinforced concrete walls.

The concrete wall thickness is greater than the thickness required to resist perforation of the wall by the design rigid missile.

The control of scabbing from the inside face of the walls is less critical than the roof as the walls are not located over the Reactor Pool.

4.4.3.3.4 Thermal Forces

4.4.3.3.4.1 Generally

The principal criteria governing the design of the reactor block are seismic and temperature effects.

Stresses are induced in the high-density concrete by the temperature gradient due to the dissipation of the heat generated in the Reactor Pool at the core level. Tensile stresses produced in this way, combined with tensile stresses due to concrete shrinkage, may initiate cracking in the block. Such cracking, and the width of the cracks, needs to be controlled and minimised in order to maintain the shielding function of the high-density concrete of the reactor block.

The reactor block is restrained by the concrete floor structure at each level, and this restraint will increase the risk of thermal and shrinkage cracking. The block itself was poured some time after the floors are completed and this means that at least 25% of the shrinkage of the concrete in the floors had already taken place before the restraint is applied.

The arrangement of the reinforcement within the massive concrete sections was utilised to limit crack widths and achieve a cracking pattern that does not compromise the shielding function of the concrete.

4.4.3.3.4.2 Analysis of Reactor Block Under Thermal Effects

The reactor block has been modelled and analysed using SAP 2000 NL to determine stresses arising from the temperature gradient. The restraining effect of floor structures has been included in the model. Vertically acting loads due to dead weight of the reactor block concrete and the dead plus live loads from the supported floor areas have also been taken into account.

4.4.3.3.4.3 Design of Reinforcement

A number of vertical layers of reinforcement consisting of vertical and circumferential horizontal bars are provided within the high-density concrete walls of the reactor block. The cross-sectional areas of steel in each layer are proportioned to resist the total axial or tangential forces within the equivalent proportion of the reactor block wall. The stresses in the reinforcement and the bar diameters and spacings are selected so as to limit cracking.

Radial reinforcement is also provided to support the vertical layers and at the same time to resist radial thermal stresses on the same basis as above.

Note that the tensile thermal stresses used in calculating reinforcement quantities were factored up by about 25% to make allowance for concrete shrinkage effects.

4.4.3.4 Structure Description

4.4.3.4.1 Footings

The Reactor Building footings are integral with the floor and are founded in the Class III/II sandstone. Concrete grade is 32 MPa, and reinforcement is provided as necessary to resist stresses due to loading conditions, shrinkage etc.

4.4.3.4.2 Walls and Columns

The majority of the reinforced concrete walls are designed, in terms of concrete thickness and reinforcement, on the basis of seismic or radiation shielding criteria or both.

4.4.3.4.3 Reactor Block and Related Structure

The general structural layout of the Reactor Block is shown on Figures 4.4/12B. It is constructed wholly of high-density concrete with the exception of a normal-weight concrete wall which is integral with the side of the Block. Reinforcement layers within the block have been located and proportioned to resist the necessary combinations of shrinkage, thermal, and seismic stresses as well as those arising from dead and live loadings.

4.4.3.5 Materials and Construction**4.4.3.5.1 Normal-Weight Concrete**

The production, supply, placement and testing of concrete for the Reactor Facility has been in accordance with relevant codes, in particular AS 1379-1997 "The Specification and manufacture of concrete".

Note that design of reinforced concrete for the Reactor Building has been carried out in accordance with the code most widely recognised and applied in the nuclear industry.

Fire rating for all reinforced concrete structural elements of the Reactor Building is 4 hours.

4.4.3.5.2 High-density Concrete

High-density concrete was used in the reactor block and hot cells, the neutron beam structures and in some of the walls between resin tanks. The exact extent of the high-density concrete is shown on the drawings.

The final mix design was developed by a series of trials using various combinations of high-density coarse and fine aggregates.

4.4.3.5.3 Reinforcement

Criteria (in compliance with the above Codes) are as follows:

4.4.3.5.3.1 Bars

Yield Strength	500 MPa minimum
Minimum Elongation at UTS	16%

4.4.3.5.3.2 Welded Wire Mesh

Yield Strength	500 MPa minimum
----------------	-----------------

4.4.3.5.3.3 Generally

Density	7850 kgm ⁻³ .
Modulus of Elasticity Es	2 x 10 ⁵ MPa.

4.4.3.5.4 Structural Steel

Structural steel members used in the Reactor Building structure shall be hot-rolled sections (or welded I – sections) Grade 300 in compliance with AS/NZS 3679.1 (or AS/NZS 3679.2) and AS 4100-1998.

Where used for connecting structural steel members, steel bolts, nuts and washers are high strength hot dip galvanised in compliance with AS/NZS 1252.

Where connections are made by welding, all welding consumables and deposited weld metal complies with AS/NZS 1554.21.

Welded studs were used to achieve composite action between structural steel and concrete, these complied with, and were installed in accordance with, AS 1554.2.

4.4.3.5.5 Masonry

Masonry walls within the Reactor Building have been constructed of concrete blockwork. They do not form part of the structure that supports gravity loads or resists seismic forces. However they are required to resist out-of-plane seismic forces due to their self-weight and accordingly therefore, they generally have all cores concrete filled and have either vertical reinforcement or vertical posts grouted into certain cores. Blocks comply with AS 2733 and workmanship with AS 3700.

4.4.4 Air-locks, Hatches and Penetrations

The containment has air locks, hatches and service penetrations for operational purposes and they are detailed in Chapter 7.

These operational features include:

- a) SAS (Safe Access Systems) for people and materials comprised of an airlock linked through one door to the containment area and through another to the area outside the containment. The doors have seals and the airlock has provision for testing of leak tightness.
- b) Hatches for transfer of large items of equipment. These are also provided with seals and provisions for testing of leaktightness.
- c) Penetrations for power cables and instrument and control cables: Seals are provided around the cables with intermediate chambers for testing for leaktightness.
- d) Penetrations for pipes: Large diameter pipes have system and situation specific designs for where they penetrate the containment walls to ensure leaktightness. Small pipes have similar arrangements to those used for instrument and control cables.

End of Section

Table 4.4/2 Load Case 1: Earthquake in East/West Direction (SSE)

Level	Total Shear Force (kN)	Shear Force Distribution to Major Shear Walls			Deflections (mm)	
		RW1 Grid O	RW4 Grid S	Reactor Block	East/West	North/South
Roof	3083	-	-	-	6.4	1.5
EMWT	6806	-	-	-	5.4	1.3
Reactor Hall	22605	48.8%	32.3%	-	4.8	1.0
Technical Floor	58401	49.2%	42.0%	7.3%	4.0	1.0
Technical Offices	68695	37.6%	41.2%	20.9%	3.7	0.6
Main Entrance	83782	31.4%	30.2%	38.0%	2.5	0.5
Beam Hall	98657	28.6%	30.9%	40.2%	1.4	0.1
Basement	110352	30.0%	34.6%	25.8%	0	0

Table 4.4/3 Load Case 2: Earthquake in North/South Direction (SSE)

Level	Total Shear Force (kN)	Shear Force Distribution to Major Shear Walls						Deflections (mm)	
		RW5 Grd 5/6	RW27 Grd 4/5	RW31 Grd 7/8	RW32 Grd 8/9	RW33 Grid 9	Reactor Block	East/ West	North/ South
Roof	3451	60.0%	-	-	39.9%	--	-	1.1	8.2
EMWT	7605	60.0%	-	-	39.9%	-	-	1.0	6.0
Reactor Hall	22985	51.0%	-	-	41.0%	5.5%	-	0.9	5.0
Technical Floor	57027	27.7%	-	10.3%	28.1%	22.5%	10.4%	0.8	4.2
Technical Offices	68805	21.1%	-	29.8%	23.2%	18.5%	6.7%	0.8	3.6
Main Entrance	83888	17.3%	0.5%	24.9%	11.0%	14.8%	30.4%	0.5	2.5
Beam Hall	99320	5.2%	11.7%	15.7%	9.9%	18.7%	38.0%	0.4	1.1
Basement	110962	12.1%	11.5%	10.6%	5.4%	15.6%	38.6%	0	0

Table 4.4/4 Global Dynamic Response of the Reactor Building Structure

Mode No.	Period (sec)	Eff. Mass, (%) Transl. X	Eff. Mass, (%) Transl. Y	Eff. Mass, (%) Rotat. Z
1	0.184	0	71	2
2	0.157	73	0	0
3	0.108	0	1	63
4	0.063	0	6	2
5	0.044	7	0	0
6	0.040	0	2	2
7	0.038	0	3	2
8	0.032	1	0	1
9	0.031	4	0	0
10	0.030	0	3	0
11	0.029	1	0	0
12	0.027	0	0	2
13	0.023	0	0	8
14	0.022	1	0	0
15	0.021	0	0	0
16	0.020	0	0	1
17	0.018	0	0	1
18	0.018	1	0	0
19	0.017	0	0	0
20	0.016	0	0	3

End of Tables

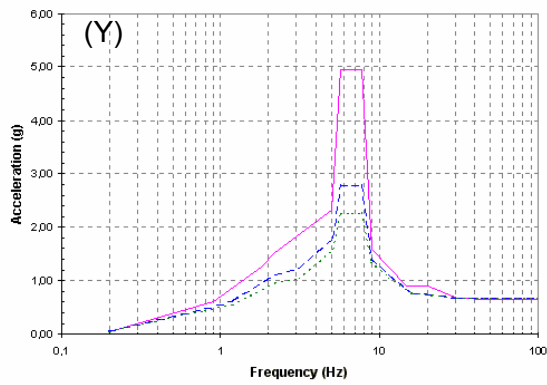

Figure 4.4/15A: Technical Floor

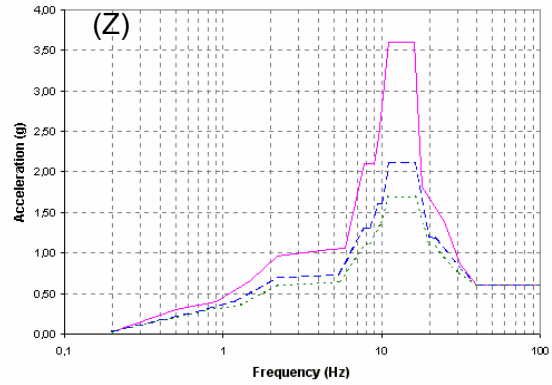

Figure 4.4/15B: Technical

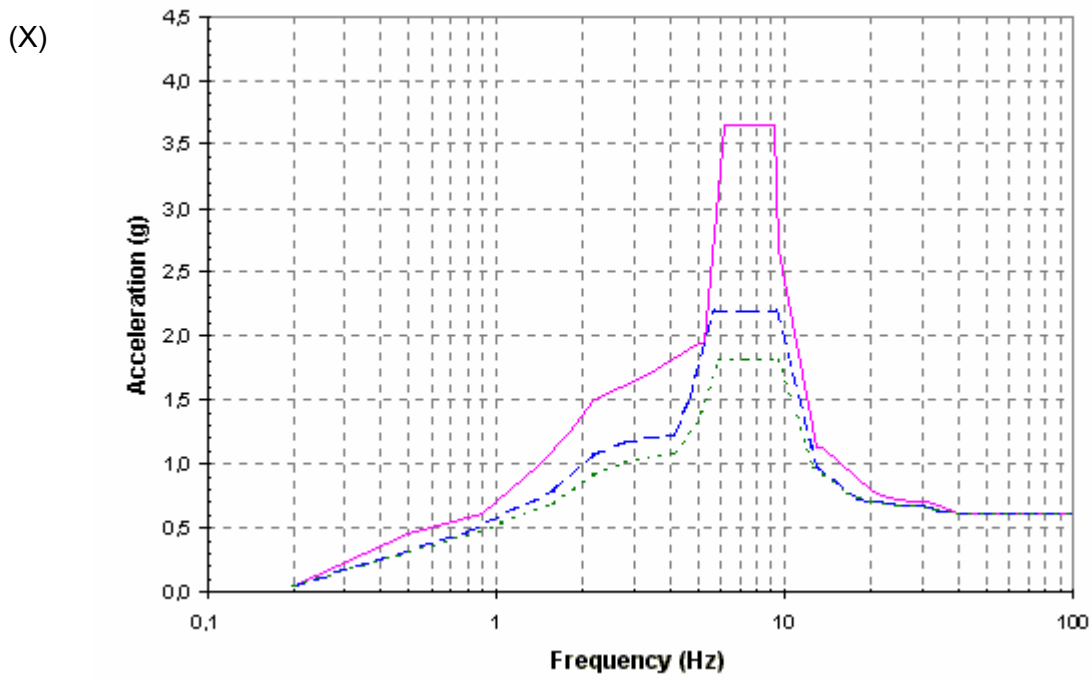

Figure 4.4/15C: Technical Floor

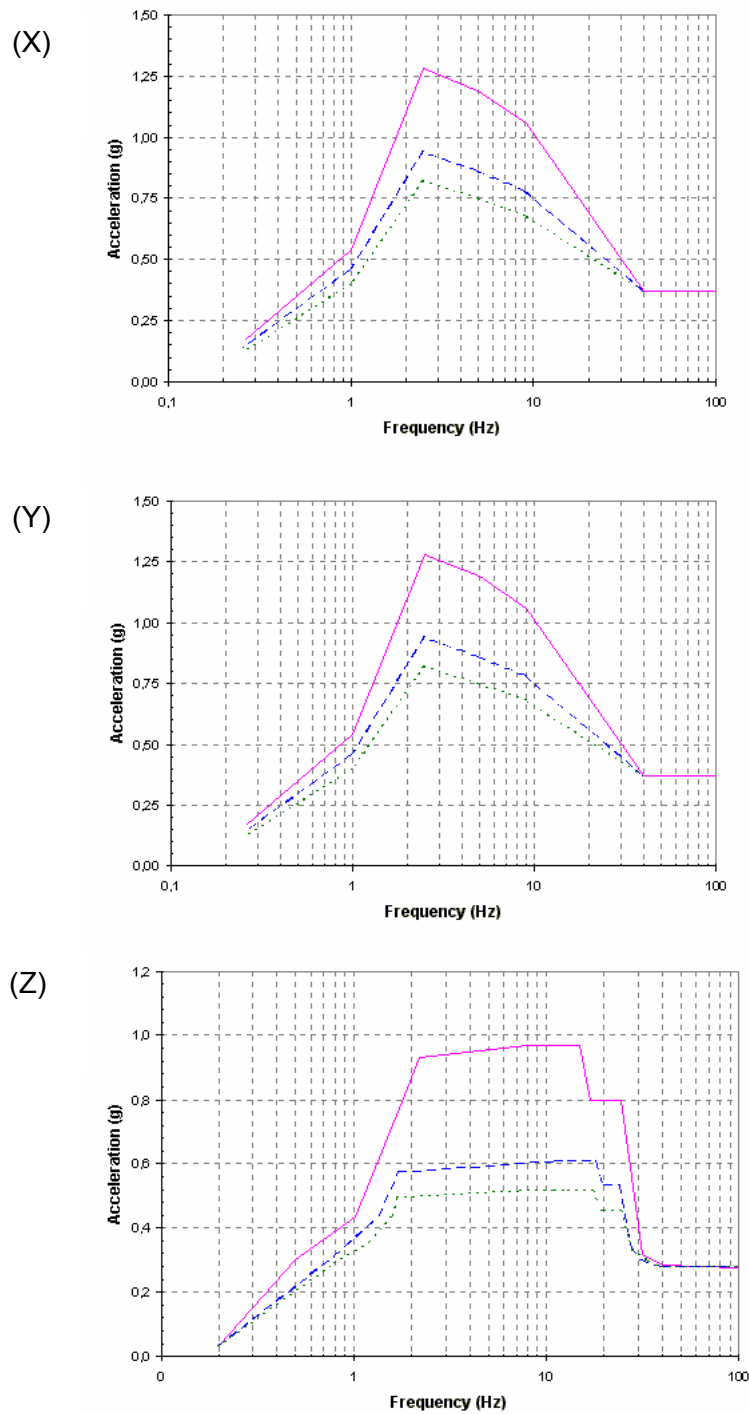

Figure 4.4/15D: Basement

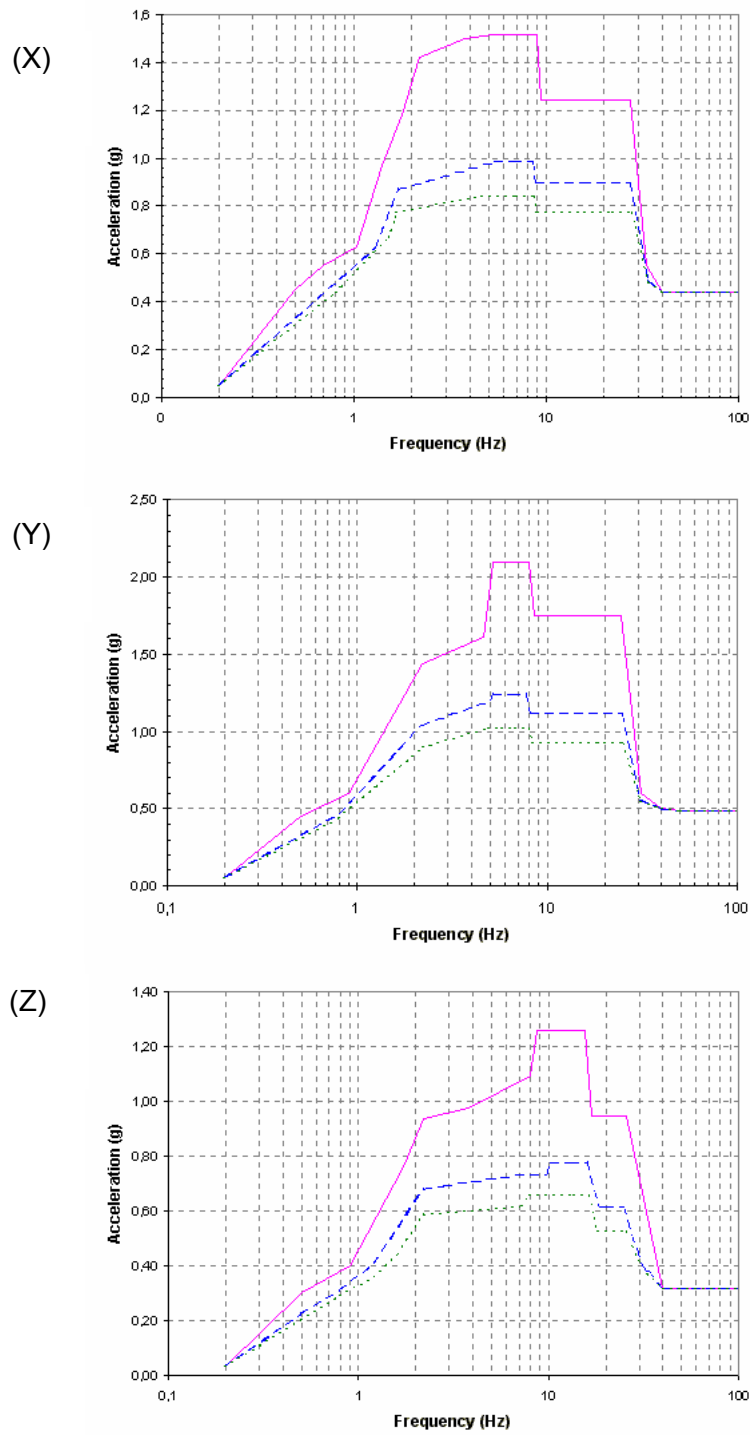

Figure 4.4/15E: Beam Hall Level

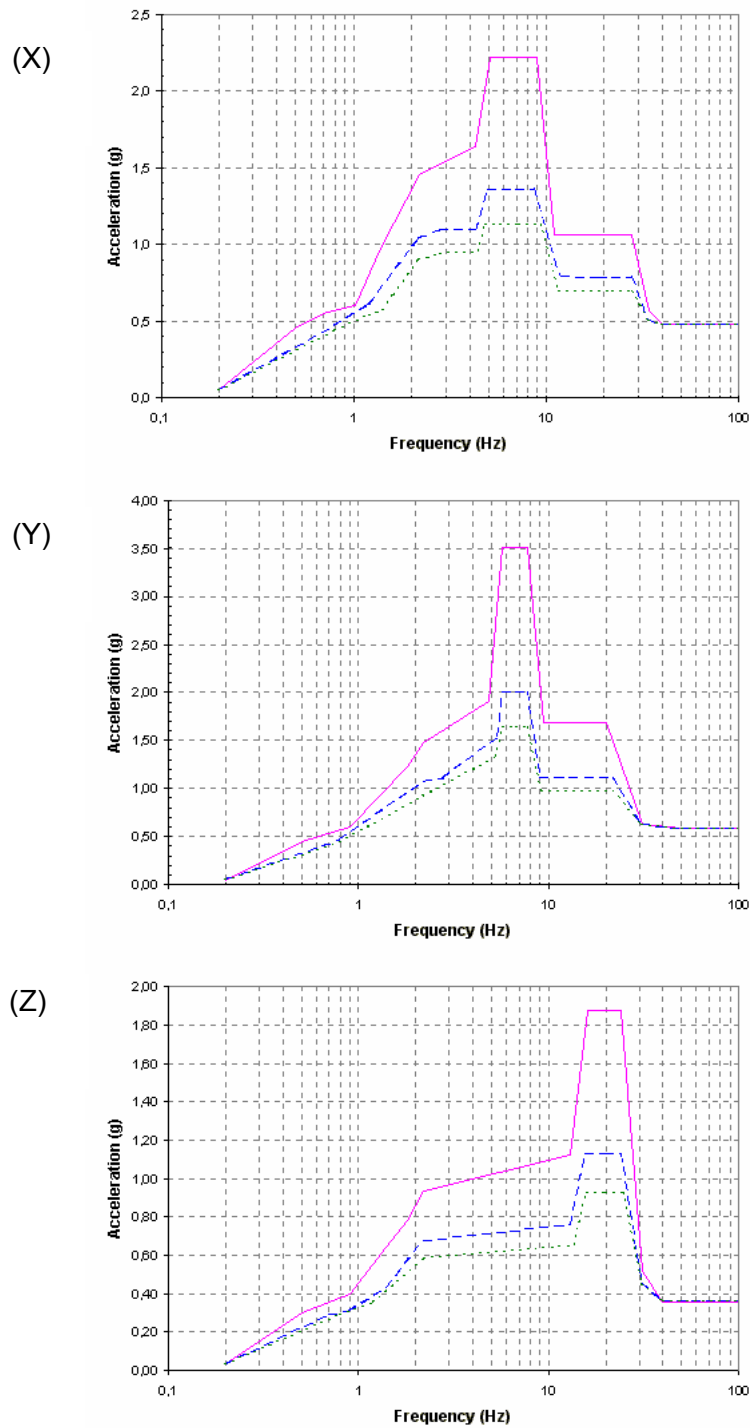

Figure 4.4/15F: Main Entrance Level

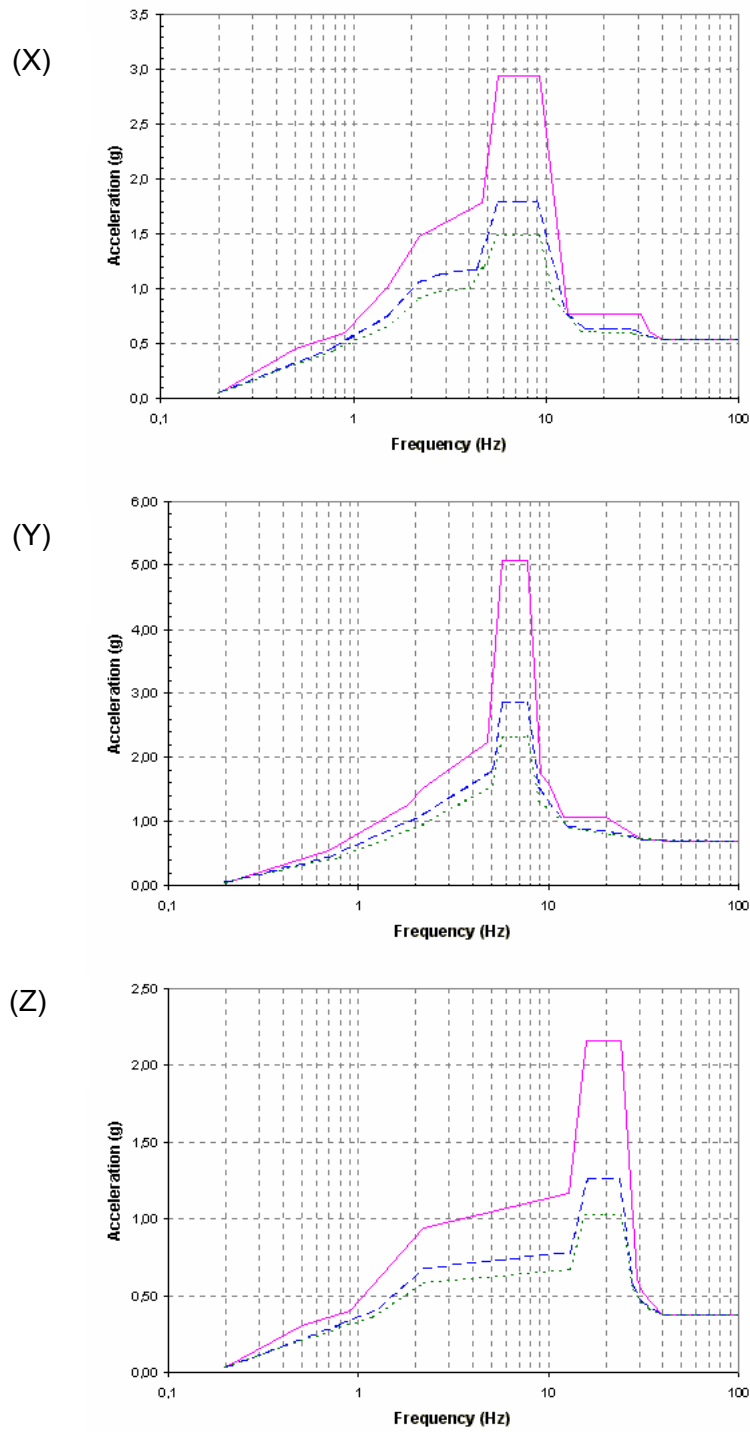

Figure 4.4/15G: Technical Offices Level

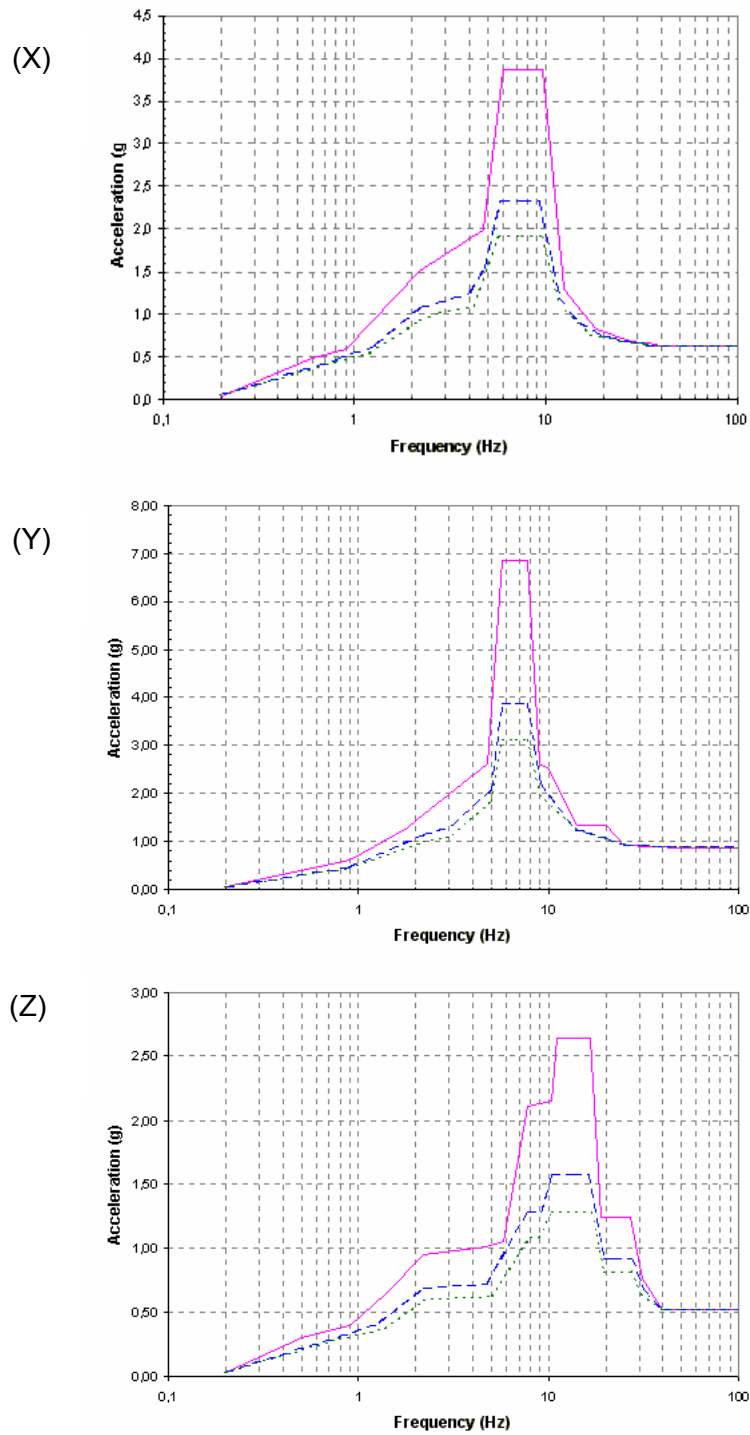

Figure 4.4/15H: Reactor Hall Level

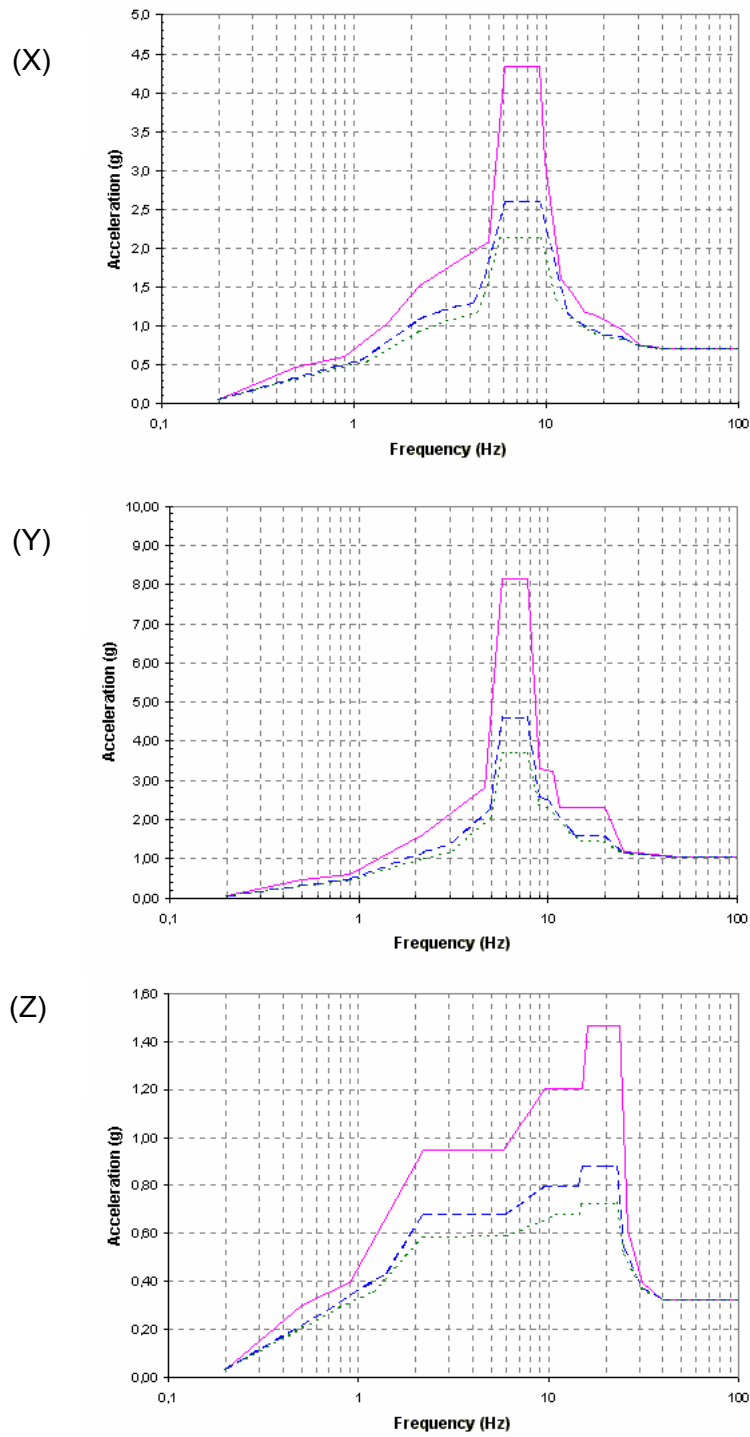

Figure 4.4/15I: EMWT Level

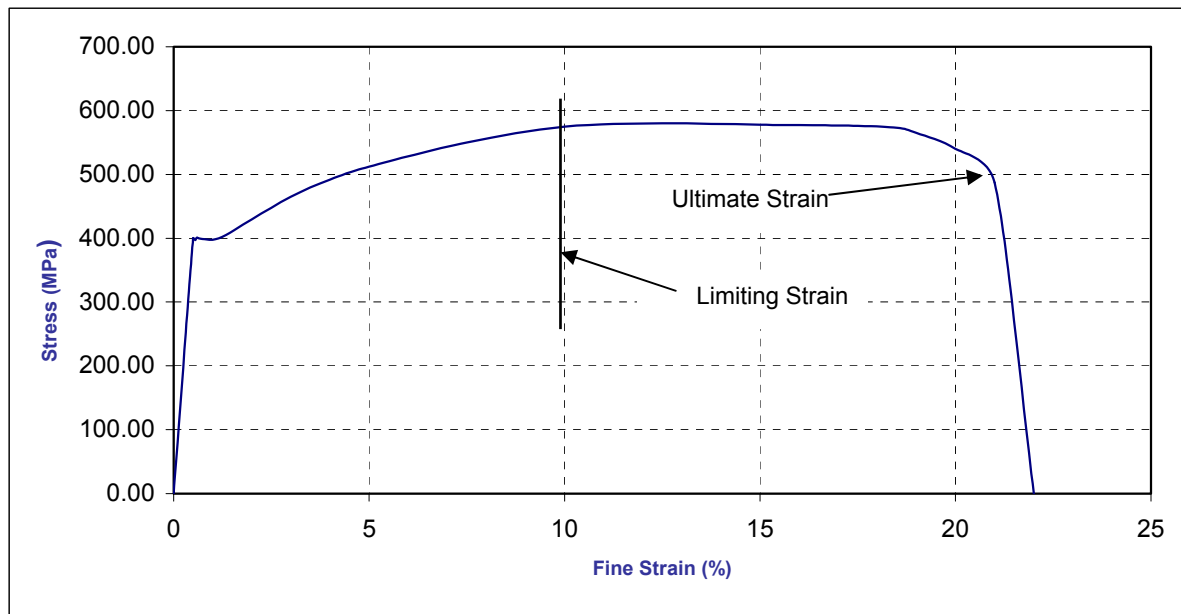

Figure 4.4/19

End of Figures

4.5 REACTOR BUILDING INTERNAL STRUCTURES & SYSTEMS

4.5.1 Reactor Pool and Service Pool

4.5.1.1 Introduction

The Reactor Pool and Service Pool are the main reactor building internal structures located inside the containment system. The pools are open tanks, connected with each other in thermohydraulic equilibrium by means of the transfer canal.

The Reactor Pool contains the following:

- a) The core and associated core structures (Chapter 5, Section 5.2).
- b) The reflector vessel (Chapter 5, Section 5.2) with irradiation positions, cold neutron source and neutron beam structures (Chapter 11).
- e) The water inventory required for the core and pool cooling systems to perform their functions (Chapter 6, Sections 6.2 and 6.3).

The Service Pool provides space for temporary storage of irradiated fuel elements (Chapter 10, Section 10.1), temporary storage of irradiated material, and space to perform operations with irradiated materials.

The Reactor Pool is connected through its base with the Control Rod Drive (CRD) Room (refer Chapter 5, Section 5.2)

The Reactor Pool, Service Pool and CRD Room are embedded in the concrete block surrounding the reactor

The pool internals can be accessed from the Reactor Hall. An Operations Bridge is provided to facilitate work within the pools.

4.5.1.2 System Categorisation

System	Safety Category	Seismic Category	Quality Category
Reactor Pool	1	1	A
Service Pool	1	1	A
Transfer Canal	2	1	B
Operations Bridge	2	1	B

All penetrations to the Reactor Pool that constitute part of the Reactor Pool coolant boundary are classified Safety Category 1, Seismic Category 1 and Quality Category A components.

The components of the Neutron Beam Tube assemblies and Control Rod Drive Room Safety Door that are part of the Reactor Pool Boundary are classified Safety Category 1, Seismic Category 1 and Quality Category A components. The Mechanism Penetration is classified Safety Category 2, Seismic Category 1 and Quality Category B.

4.5.1.3 Safety Functions

1. The Reactor Pool performs the following safety functions:
 - a) ensures that the Primary Cooling System (PCS) has available sufficient reactor coolant to remove heat from the core by forced circulation during power operation and by natural circulation when shut down. Cooling is required during normal operation, and during and after any accident situation.

-
- b) provides protection from radiation exposure to operating staff.
2. The Service Pool performs the following safety functions
- a) ensures safe storage of the stored spent fuel elements and irradiated material during normal operation and during and after any accident situation. This function relies on the pool liner containing the necessary inventory of water to ensure cooling is provided at all times.
 - b) provides radiation protection to the operation staff and research personnel.
3. The Transfer Canal and the Operations Bridge perform the following safety function:
- a) Provides a means of isolating the two pools and facilitate maintenance activities requiring the water level in either of them to be lowered.

4.5.1.4 Codes and Standards

The following codes and standards have been used in the design of the Reactor Pool Service Pool and Transfer Canal, and the Operations Bridge.

- a) Reactor Pool, Service Pool and Transfer Canal:

ASME Boiler and Pressure Vessel Code, as a guide in material selection, design, construction and test for Atmospheric Storage Tanks, with supplementary inspection requirements.

- b) Operations Bridge:

AS 1418-1994 Cranes (including hoist and winches)

AS 1657-1992 Fixed Platforms, walk-ways, stairways and ladders – Design, construction and installation.

4.5.1.5 Reactor Pool

4.5.1.5.1 Design Basis

The Reactor Pool has been designed to satisfy the following requirements:

- a) To maintain Reactor Pool water for the PCS and RSPCS to perform the function of core cooling.
- b) To provide biological shielding.
- c) To ensure that the Reactor Pool water inventory performs the function of ultimate heat sink for post-shutdown reactor power by receiving the core decay heat extracted by natural circulation of pool water.
- d) To provide a water envelope around the reactor core that extends above the safe water level in the Reactor Pool and an appropriate boundary to prevent the water in the Reactor Pool decreasing below that level during all reactor states and all design basis accidents.
- e) To provide mechanical support for the reactor core and associated structures.
- f) To provide mechanical support for all the reactor internals, e.g. reflector vessel, irradiation facilities, cold neutron source and neutron beam assemblies.
- g) To provide exits from the tank for the pneumatic conveyor tubes.

- h) To provide a water-tight connection with the Control Rod Drive Room for the penetration of the Control Rod Drives.
- i) To provide a means for detection of leaks from the pool.

The following Design Bases are adopted to fulfil the requirements:

	Normal condition		Abnormal Condition	
	Maximum	Minimum	Maximum	Minimum
Process Fluid	Demineralised water		Demineralised water	
Temperature	50° C	15° C	100° C	Atmospheric
Humidity	100%		Atmospheric	Atmospheric
Seismic	None		According to seismic category 1 classification	

4.5.1.5.2 Description

4.5.1.5.2.1 General Description

The Reactor Pool is an open cylindrical pool. Table 4.5/1 includes a list of the Reactor Pool internal components.

The Reactor Pool is embedded in a concrete block that receives the loads acting on the pool. The load is transferred to the concrete through the lateral wall of the pool and through the bottom plate, which rests on the concrete block. Five carbon steel stiffening rings are welded at different heights on the external face of the lateral wall to provide structural stiffness. The rings are keyed into the concrete block, Direct welding of the carbon steel stiffening rings to the stainless steel pool wall is avoided by the use of an austenitic stainless steel interface plate between the ring and the pool wall. In this way the Reactor Pool is protected from the potential problems involved with carbon steel-stainless steel welding.

The exterior of the Reactor Pool lateral wall is covered by a membrane used for leak detection, described in Section 4.5.1.5.2.5

4.5.1.5.2.2 Penetrations to the Reactor Pool

The design of the penetrations through the Reactor Pool tank has the main safety objective of preventing their being a potential breach in the capacity of the Reactor Pool boundary to ensure availability of the water inventory that protects core integrity. Initiating events associated with the potential breach of the Reactor Pool boundary are analysed in Chapter 16, Section 16.11.

The Reactor Pool safety design is based in the following characteristics:

- Protection is provided in the form of siphon breakers that prevent loss of coolant from the process systems that could decrease Reactor Pool water level below the safe level.
- Penetrations corresponding to process system pipelines and instrumentation ducts are located, where possible, above siphon breaker level
- Penetrations that cannot be located above siphon breaker level are provided with protective boundaries to prevent leakage that could lead to a loss of coolant accident (LOCA).

Penetrations Above Siphon Breaker Level

These include penetrations of the Primary Cooling System (PCS) and Reactor and Service Pool Cooling System (RSPCS) piping, instrumentation and Reflector Vessel pressure equalisation line at siphon breaker Level. Penetrating pipes are welded to the pool to provide material continuity.

The penetrations for the Hot Water Layer System (HWLS) inlet and outlet pipes, Cold Neutron Source (CNS) service lines, provisions for process pipelines and the Transfer Canal neck are located above siphon breaker Level. Emergency Make-up Water System (EMWS) pipes and additional Cold Neutron Source piping penetrate the Reactor Pool lateral wall above the Reactor Pool nominal water level.

Two Pneumatic Conveyor Chambers which are provided for the Pneumatic Sample Transport System tubes continue above the Reactor Pool water level. Additional concrete and lead shielding is provided in this area.

Penetrations below Siphon Breaker Level

a) Process Piping Penetrations

Process piping penetrations below siphon breaker Level include the Second Shutdown System (SSS) discharge pipe and Reflector Coolant and Purification System (RCPS) piping. A seal assembly is used to provide water tightness. The seal assembly is composed of three static c-rings and leak detection system on each seal for each pipe. In the event of seal failure on any of the penetrations, leakage of pool water would be into the CRD Room.

b) Mechanisms Penetration

The Mechanisms Penetration is a cylindrical structure embedded in the concrete block between the Reactor Pool and the Control Rod Drive Room. A stainless steel shell covers the connection inner wall.

To prevent loss of water into and from the Control Rod Drive Room, two protective barriers are provided:

- (i) the CRD Room penetrations with multiple seal systems that provide a water-tight passage between the Reactor Pool and the CRD Room.
- (ii) the CRD Room Safety Door; a water-tight component that prevents loss of water from the CRD Room to the basement pools.

Inside the connection there is a structure that allows the penetration into the Reactor Pool of the Control Rod stems without allowing Reactor Pool water to enter the CRD Room. At the lower part of the connection there is a leakage chamber located between the connection wall and the shielding container. Figure 4.5/5 shows a cross section view of the CRD Room Connection.

A seal assembly is provided on each of the penetrating components to provide water tightness.

The CR seal assembly is comprised of a stainless steel body containing the seals. A Wiper seal, for seal cleaning, and two polypack seals are used between the CR stem and the seal bushings. A leak detector is placed between the two polypack seals. O-ring seals are used in the static parts of the components.

c) Control Rod Drive Room Safety Door

The Control Rod Drive Room is protected by a water and airtight safety door, which constitutes a barrier against flood, overpressure, and release of radioactive products. It is a tilting-door made of painted carbon steel sheet, with welded "L" shaped reinforcing ribs and a fixed gasket.

The door case is fixed to a concrete frame. The door rotates on a pair of hinges and tilts over another pair of tilting hinges to provide a seal against its case. Door movement is manual and it is locked by pneumatic clamps. When the door is closed, it rests against rigid stops that restrain the compression of the elastic gasket and the load on the closing clamps.

The door design pressure is sufficient to hold the pressure of the Reactor Pool water column. The door has double seals around its perimeter which can be tested during reactor operation. In the unlikely event of a catastrophic failure of the CRD Room seals that fills the CRD Room with Reactor Pool water, the safety door can hold by itself as a part of the Reactor Pool boundary. In this event, the volume of the CRD Room limits the decrease of the Reactor Pool water level and the Reactor Pool would remain filled with water up to a level above the siphon breakers.

The safety door will be normally closed during reactor operation. A detector will indicate and provide alarm in the control room for the door open condition.

The CRD Room is provided with a leak detection gutter on the floor, with alarm in the control room.

Should the CRD Room be flooded it could be drained by means of a pipe connected to a pump to the Effluent Disposal System.

d) Neutron Beam Assemblies Penetrations

On the lateral Reactor Pool wall there are five penetrations for the neutron beam assemblies, below the siphon breakers.

Neutron beam assembly penetrations to the Reactor Pool are provided with two static barriers to prevent the loss of reflector vessel and Reactor Pool water. Each barrier has been designed to withstand the hydrostatic pressure of the water column of the Reactor Pool.

The first barrier is the beam tube enclosure. The enclosure is fixed to the reflector vessel and to the shielding components at two positions, by means of bolted flanges with double metallic seal each.

The second barrier consists of a stainless steel closure plate at the reactor block external face. This plate covers the beam tube and shutter system. It has a rubber static seal and is bolted to the reactor block. A rectangular opening in the plate provides passage for the neutron beam guide. The opening is covered by a aluminium sheet which is designed to withstand the water column pressure of the Reactor Pool, and is provided with a rubber static seal

The second barrier includes also two static rubber seals, one at the transmission shaft end and another at the service pipe end.

The beam assemblies are flushed with helium gas. Measurement of the relative humidity of the helium will indicate the presence of Reactor Pool or reflector vessel water in the beam assemblies and enable detection of very small leaks. Water from larger leaks would be detected at the leak detection.

Neutron beam assembly bellows are provided with shields for protection against impacts by falling objects

4.5.1.5.2.3 Reactor Pool Ventilation, Instrumentation and Overflow Canal

The upper parts of the Reactor Pool, Service Pool and Transfer Canal have a continuous extension and associated structure (canal) up into the Reactor Hall. This structure constitutes a perimeter handrail and is identified as the Ventilation, Instrumentation and Overflow Canal (VIO Canal). Its purposes are as follows:

- a) to collect overflow water
- b) to support ventilation air nozzles (Only the RPO)
- c) to be an instrumentation cable canal
- d) to establish a perimeter barrier around the pool opening in the Reactor Hall floor.

4.5.1.5.2.4 Support Structures Affixed to the Reactor Pool

Internal Reactor Pool components are affixed to the Reactor Pool by means of several types of supports and fixing devices designed to prevent water stagnation zones that could be potential corrosion areas.

Some of the support devices are used to hold components permanently in place, such as core and core associated structures. Other support devices are attached to the Reactor Pool wall and floor to be used temporarily for lighting fixtures, racks and tools. Removable elements are located away from the core, meeting operating requirements to minimise the activation of materials.

The support structures for other reactor internal components are welded to the Reactor Pool wall. Those supports that receive high loads are either coincident with the outer stiffness rings or having additional backing to directly transfer the loads to the reactor block.

The Reactor Pool floor receives the load of the core and core associated structures (Chapter 5, Section 5.2). The load is then transferred to the reactor block.

Internal components that on account of reactor operation and/or maintenance reasons may need to be removed are locked with mechanisms that are accessible from the pool surface.

4.5.1.5.2.5 Reactor Pool Leak Detection

The Reactor Pool is provided with a leak detection system.

Leak location is identified by means of leak detection zones on the Reactor Pool as follows:

- a) Reactor Pool lateral wall: leak detection areas along cylindrical strips that fully cover the Reactor Pool lateral wall.
- b) Reactor Pool floor: leak detection areas that cover the floor plate welds.

On the Reactor Pool lateral wall the detection system consists of:

- Membrane film
- Collection gutters
- Drain Tubes

On the Reactor Pool walls a watertight membrane film is wrapped around the pool outer surface to form each detection area. The layers are sandwiched between the Reactor

Pool wall and the concrete reactor block. This combination is a standard solution in civil construction to drain water.

Each detection area has a collection gutter laid horizontally around the pool. Thus, water from a leak in a given detection area would percolate down through the membrane towards the corresponding collection gutter. Each gutter has two drainage pipes located on opposite sides of the pool perimeter. Both drainage pipes are connected to a single drainage pipe that will carry any leakage water to the monitoring station.

Reactor Pool floor detection areas are defined by the floor plate welds. The water collection device has a drainage pipe that conducts any water from leaks towards the monitoring station.

The monitoring station is a central collection point for the leak detection system. The outlet of each drainage pipe is connected to the monitoring station and identified with its corresponding detection area. In case of leakage, water from any of the drainage pipes will be collected in a tundish. There will be a space between the drainage pipe outlets and the tundish sufficient to allow an operator to see clearly any water flow and identify its source. Any water collected in the tundish is drained to the Effluent Disposal System.

4.5.1.5.3 Materials

The Reactor Pool is made of stainless steel, which has the required resistance to corrosion for the temperature and water quality in the pool. Irradiation damage effects will be insignificant taking into account the radiation influence on this component.

Stiffening rings are made of carbon steel. In places where the stiffening rings or other carbon steel components needed to be welded to the stainless steel pool liners, a stainless steel transition plate has been used to ensure that there are no dissimilar metal welds to the pool liner. Carbon steel components and the dissimilar metal welds are not in contact with water so no corrosion problems are expected. Irradiation damage effects are similarly expected to be insignificant.

Additional details on reactor materials are given in Chapter 5, Section 5.9.

4.5.1.5.4 Design Evaluation of the Reactor Pool

The water inventory in the Reactor Pool is ensured by the structural integrity of the pool. The Reactor Pool structural integrity is provided by the conservative use of appropriate design standards and by the quality of its construction.

The Reactor Pool has been designed according to ASME Boiler and Pressure Vessel Code, Section III, Division 1, Subsection ND, which defines the requirements for the pool to withstand the hydrodynamic, hydrostatic and mechanical forces, ensuring its integrity during its projected lifetime. The Reactor Pool calculations have been performed by means of the PV Elite Version 3.6, CODAE Engineering Software which follows the ASME Code and by FEM analysis for seismic and temperature conditions

Large safety margins have been adopted in order to ensure proper Reactor Pool performance. The specified thicknesses for the Reactor Pool walls and bottom are respectively 37% greater and 100% greater than that required by the ASME Code.

Although not required by ASME code, either because of the diameter for small penetration or because of the adequate thickness of the shell, all penetrations are externally reinforced.

Special temporary structures were used inside and at the bottom of the tank to provide stiffness during transportation, mounting and concrete pouring. These structures were

designed to support the loads arising from the different operations during transportation and mounting and prevented deformation of the pool liner.

The behaviour of materials used in the Reactor Pool indicates that corrosion effects will be negligible taking into account the conditions imposed on the water quality for conductivity and temperature. Operational limits and conditions have been imposed for the values of these parameters to meet the water quality requirements presented in Chapter 6. In accordance with the estimated neutron fluence to be received by the pool liner during its lifetime irradiation damage effects will be negligible.

The requirement on the Reactor Pool to ensure water is maintained at the safe level is met by the provision of redundant siphon breakers on the process pipelines. Siphon breakers prevent drainage of the pool during any postulated Loss of Coolant Accident (LOCA) event and allow the opening of the Primary Cooling System and Reactor & Service Pool Cooling System flap valves to establish the natural circulation when required for core protection.

The reliability of the Reactor Pool boundary relies on fully passive components. All penetrations are welded, each one is able to sustain the pressure of the Reactor Pool water column by itself and has leak testing capability. Penetrations are tested for leak tightness during construction.

A double barrier against a Loss of Coolant Accident (LOCA) through the Control Rod Drive Room connection is provided. The first barrier is the double seal assemblies on the Control Rod penetrations. Leaks through the seals in the Control Rod Drive Room connection will be detected by the leak detectors in the seals or by the leak detectors in the Control Rod Drive Room floor, in case of failure of the double seal barrier. The second barrier is the Safety Door of the Control Rod Drive Room which has a double seal and leak testing provisions. As the Control Rod Drive Room is watertight, any leak through the Control Rod Drive Room Connection would be limited by the volume of the room, which implies an equivalent decrease in the Reactor Pool water level. Both barriers are designed to withstand the pressure due to the water column in the Reactor Pool. The barrier components fulfil the requirements of Safety Category 1 and are designed to withstand all seismic events with elastic behaviour.

The beam tube assemblies are also provided with a double barrier. All joints between the components of both barriers have seals. Each barrier, its components and seals, is designed to withstand the pressure due to the water column in the Reactor Pool and its components are designed according with the Safety Category 1 and Seismic Category 1 requirements. Provisions for early detection of leaks through the beam tubes are included in the design.

The massive concrete structure of the reactor block in which the stainless steel Reactor Pool boundary is embedded represents an additional barrier that, in the event of pool damage, would limit the extent of any leakage. The leak detection system between the Reactor Pool and the reactor concrete block would allow early detection of any leaks and appropriate corrective actions.

The dimensions of the Reactor Pool take into account the requirements for both axial and radial shielding provided by the water in the pool. Dose calculations reported in Chapter 12, for the estimation of doses at the top of the pool, Reactor Hall and CRD Room demonstrate that the dose limits are not exceeded.

Seismic evaluation of the beam tube boundaries and Control Rod Drive Room Safety Door indicates that the components, including the barriers against Loss of Coolant Accident, can withstand a seismic event well in excess of the SL-2 earthquake without failure.

4.5.1.5.5 Seismic Analysis of the Reactor Pool

The seismic analysis is done in order to verify the structural integrity of key components associated to the pool in the case of postulated earthquakes.

There are two levels of protection to prevent a Loss of Coolant Accident (LOCA), termed Level 1 and Level 2. Components classified as Level 1 are those that constantly support the same hydrostatic pressures due to the water level above them. These components have been verified for these normal operation loads as well as for seismic loads. Components classified as Level 2 are those that would be subjected to a peak load only if a Level 1 component fails.

Level 1 and Level 2 components can be thought as two redundant barriers in series to prevent a LOCA. If barrier 1 (ie. a Level 1 component) fails, then barrier 2 (a Level 2 component) has to support the loads and ensure confinement of the coolant to a restricted space.

For example, if a seal box (Level 1 component) fails and a LOCA occurs, then the Control Rod Room door (Level 2 component) will support the hydrostatic pressure, preventing coolant from leaving the control rod room and maintaining water in the Reactor Pool at a safe level.

An analysis of the Beam Tubes, Control Rod Drive Room Safety Door, Guide Windows and Neutron Beam Front Covers shows that both the hydrostatic and seismic loads will be maintained within allowable displacement and stresses

4.5.1.6 Service Pool

4.5.1.6.1 Design Basis

The Service Pool has been designed to meet the following requirements:

- a) to ensure that the Service Pool water is available to cool the stored spent fuel and other irradiated material
- b) to provide biological shielding.
- c) to ensure that the Service Pool water inventory can perform the function of heat sink for the spent fuel and irradiated material stored in the pool by receiving the decay heat extracted by natural circulation of pool water.
- d) to provide support for the spent fuel storage and other irradiated material support structures
- e) to provide adequate space and shielding for loading irradiated fuel elements into a shielded transfer cask for subsequent processing and/or storage.
- f) to include a means for leak detection.
- g) to allow underwater operations with irradiation rigs

The following Design Bases are adopted to fulfil the requirements:

	Normal condition		Abnormal Condition	
	Maximum	Minimum	Maximum	Minimum
Process Fluid	Demineralised water		Demineralised water	
Temperature	45°C	15°C	90°C	Atmospheric
Humidity	100%		Atmospheric	

Seismic	None	According seismic category 1 classification
---------	------	---

4.5.1.6.2 Description

The Service Pool is a rectangular cross section tank embedded in the concrete of the reactor block. It is connected with the Reactor Pool by the Transfer Canal. The Service Pool can be isolated by an Isolation Gate.

The Service Pool is set anchored to the reactor block in a similar way as described for the Reactor Pool.

Six standard "U" section carbon steel stiffening beams are welded on the external faces of the Service Pool lateral wall at different heights.

The Service Pool provides for:

- a) Storage facility for irradiation rigs and silicon ingots.
- b) Pool connection with Hot Cells.
- c) Underwater loading of the irradiated fuel transport cask.
- d) Temporary storage of intermediate solid waste.
- e) Storage racks sufficient for spent fuel elements generated during up to 10 years of full-power operation plus one full reactor core.
- f) An area for mechanical maintenance of rigs, and for operations such as volume reduction of internal devices, rigs, control absorbers and other disused or damaged metallic intermediate level solid wastes is included in the Service Pool.

4.5.1.6.3 Penetrations to the Service Pool

All penetrations to the Service Pool are above the bottom of the Transfer Canal.

The main penetrations are the Reactor and Service Pool Cooling System suction and return pipelines. The return pipeline has siphon breakers above the level of the bottom of the Transfer Canal.

At the top of the Service Pool, above normal water level, the VIO Canal provides the required connections for instrumentation and overflow.

4.5.1.6.4 Leak Detection in the Service Pool

The Service Pool is provided with a Leak Detection System identical to that described for the Reactor Pool.

4.5.1.6.5 Materials

The Service Pool is made of the same materials as the Reactor Pool, with the same protection against corrosion and radiation damage effects.

4.5.1.6.6 Design Evaluation of the Service Pool

The structural design, design methods and standards of the Service Pool are identical to those used for the Reactor Pool, ensuring its structural integrity during its design service lifetime.

As with the Reactor Pool, the Service Pool has fully passive boundary components. It is embedded in the massive structure of the reactor block which can serve as a second

barrier to the pool metallic boundary, it is provided with a leak detection system and its penetrations are fully inspected and tested during construction

In case of failure of the Reactor and Service Pool Cooling System, the spent fuel and irradiated material stored in the Service Pool would be cooled by natural circulation of Service Pool water, making the Service Pool highly reliable in its cooling function.

All penetrations to the Service Pool are above the level of the Transfer Canal and ensure that in case of Loss of Coolant Accident events in the Service Pool penetration pipes, or in the Reactor Pool, the water level in the Service Pool would be maintained at least at the level of the bottom of the Transfer Canal which is well above the top of the spent fuel rack. The thermohydraulic analysis performed during the Detail Engineering demonstrated that the amount of water retained in this case is sufficient to provide cooling by natural convection to the spent fuel and any other irradiated material to be stored in the Service Pool.

Siphon effect breakers on the Reactor and Service Pool Cooling System pipeline in the Service Pool impede draining of the pool during any postulated Reactor and Service Pool Cooling System Loss of Coolant Accident event and ensure that the water level is maintained to at least the level of the bottom of the Transfer Canal. Structural integrity of the Service Pool during a SL2 seismic event was fully evaluated during the Detail Engineering Stage.

Analysis of LOCA events is given in Chapter 16, Section 16.11. Consideration of these events indicates that no risks are posed in relation to the cooling of spent fuel and irradiated material in the Service Pool.

4.5.1.7 Transfer Canal

4.5.1.7.1 Design Basis

The Transfer Canal has been designed to satisfy the following requirements:

- a) To provide a passage for the transfer of fuel elements and other irradiated material from the Reactor Pool to the Service Pool.
- b) To provide biological shielding during transfer of fuel elements and other irradiated material from the Reactor Pool to the Service Pool.
- c) To provide the means to isolate the Service Pool from the Reactor Pool during reactor shutdown if it is required to partially drain the Reactor Pool for maintenance or inspection purposes.

The following Design Bases are adopted:

	Normal condition		Abnormal Condition	
	Maximum	Minimum	Maximum	Minimum
Process Fluid	Demineralised water		Demineralised water	
Temperature	45°C	15°C	60°C	10°C
Humidity	100%		Atmospheric	
Seismic	None		According seismic category 1 classification	
Neutron flux	N/A	N/A		None

4.5.1.7.2 Description

The Transfer Canal connects the Reactor Pool with the Service Pool to allow the transfer of fuel elements, rigs and irradiated materials that require underwater transportation as a means of providing shielding. The Transfer Canal provides an adequate height of water above the top level of the fuel elements during transfer.

The Isolation Gate allows isolation of the Reactor Pool from the Service Pool in order to enable reduction of the water level of the Reactor Pool independently of that in the Service Pool.

4.5.1.7.3 Materials

The Transfer Canal is made of stainless steel. The adequacy of this material for Reactor Pool components is discussed in Chapter 5.

4.5.1.8 Operations Bridge**4.5.1.8.1 Design Basis**

The Operations Bridge has been designed to satisfy the following requirements:

- a) to provide access for operation and maintenance staff to carry out operation and maintenance procedures inside the Reactor and Service Pools.
- b) to maintain its position during the design basis earthquake and not fall into the reactor or service pools..

The following Design Bases are adopted:

Parameters	Units	Normal		Abnormal	
Ambient Temperature	°C	20	25	1	47
Ambient Pressure – refer Ch 7	kPa g				
Ambient Humidity	%	40	60	N/A	100
Vibration			OBE		SSE
Peak Horizontal Acceleration	g	0	0.09	0	0.3 g
Peak vertical acceleration	g	0	0.06	0	0.2 g

4.5.1.8.2 Description

The function of the Operations Bridge is to allow the movement of the operators over the Reactor Pool, Service Pool and Transfer Canal areas to view and have vertical access to the internal areas of the pools. The bridge enables operational tasks and transfer of components and irradiated material between pools to be performed.

The Operations Bridge moves along rails embedded in the floor of the Reactor Hall and it is provided with an anti-derail system.

It uses an electrical transmission system.

4.5.1.9 Fabrication of Components

Fabrication of Reactor Pool, Service Pool, Transfer Canal and Operations Bridge was performed in accordance with the standards identified in Chapter 2.

During fabrication, no tools were used that produced contamination or degradation of the pool materials. The pools, pool sub-components and the fabrication tools were protected

to prevent bumping, scratching or other damaging effects during handling and storage operations.

The following tests were performed during fabrication of the Reactor and Service pools and Transfer Canal:

- Dye penetrant test
- X-Ray test
- Leak test (where applicable)

The extent of testing met or exceeded the requirements of the applicable codes in all instances.

4.5.1.10 Shipment and Installation

The design has made provision for the incorporation of components and structures needed for the appropriate shipment and installation of the pools and associated structures.

Containers with the required devices to facilitate hoisting and transportation were included in the design.

Covers and protection for shipment and installation to ensure pool cleanliness were included in the design.

Packing, handling, storage, transport and installation procedures required examination of the structures on arrival at site for evidence of contamination as a result of damage to shipping covers. No damage occurred during transportation to site.

Removable covers and auxiliary elements were clearly identifiable.

The pools were provided with all necessary lifting lugs for loading and unloading. A levelling frame for pool alignment operations was also provided for in the design.

Installation procedures ensure that the integrity of the pools was maintained, weather protection was provided, and periodic cleaning was performed using the construction scaffolds.

4.5.1.11 Inspection and Testing

Inspection and Testing of the Reactor Pool, Service Pool and Transfer Canal during manufacturing and installation met or exceeded the requirements of the applicable standards.

Stage A Commissioning tests will be conducted in accordance with the guidelines given in Chapter 15.

Inspection and testing during reactor operations will be carried in accordance with approved inspection and testing arrangements.

A Surveillance Plan to assess radiation damage, corrosion or deterioration during the projected lifetime of the facility has been developed. It consists primarily of the provision of a number of irradiation positions for sample targets of different materials to evaluate the effects of radiation on the mechanical properties of the materials.

4.5.2 Cranes

4.5.2.1 Reactor Hall Crane

4.5.2.1.1 Introduction

The Reactor Hall Crane is located in the Reactor Hall. The crane is used to manipulate structures and equipment in the reactor and service pools. Spent fuel shipments in casks for irradiated fuel assembly transport are expected to be handled in batches of three casks and expected to be performed every five to eight years.

4.5.2.1.2 Design Bases

The crane is designed to AS 1418 and NUREG.

The crane will withstand the Operating Basis Earthquake (OBE) without losing its operational capability after the earthquake. The crane will retain control and hold the load during the OBE event. The crane has also been designed to withstand the Safe Shutdown Earthquake (SSE) against collapse. The bridge and trolley have been designed to remain in place on their respective runways with their wheels prevented from leaving the tracks during the SSE event.

4.5.2.1.3 Description

The crane is a double girder, electric overhead travelling type. The crane is a single failure proof crane with one crab carrying both the main and auxiliary hoist units. Hoisting units and associated rope reeving systems are dual systems for each hoist. The hoist braking system includes one power control system and two holding brakes for each hoist. The hook, rope and fittings are designed to operate immersed in demineralised water.

4.5.2.1.4 Special Requirements

An oil/grease collection tray is provided under each mechanism to prevent spillage on the working area. There is restricted access by means of use of a master key to operate the crane directly over the reactor and service pools area.

4.5.2.1.5 Inspection and testing

The crane has been inspected and tested during fabrication and erection and will be further tested during Stage A commissioning in accordance with the provisions included in Construction Inspection and Test Plan.

The Stage A commissioning includes functional tests, operational tests, static and dynamic load testing. The hoisting tests include a two-blocking test with protection and safety devices bypassed.

4.5.2.2 Reactor Beam Hall Crane

4.5.2.2.1 Introduction

The Reactor Beam Hall Crane is located in Reactor Beam Hall. The crane is used primarily to manipulate research components and shielding units, and is not required to lift nuclear loads. Its runway is fixed to the underside of the concrete floor slab .

4.5.2.2.2 Design basis

The crane is designed to AS1418.

4.5.2.2.3 Description

The crane is a single girder, underslung construction, electric overhead travelling type. The crane travels on a semi-circular track. The crane girder spans in the radial direction and has an arc movement of approximately 205°. There is one crab carrying the main hoist unit.

4.5.2.2.4 Special requirements

Vibration and noise from the crane operation is designed to be as low as reasonably achievable and not affect normal operation of the neutron scattering instruments or the Safety Category 1 systems.

Operation of the crane is designed to cause minimal electrical interference to the neutron scattering instruments.

An oil/grease collection tray has been provided under each mechanism to prevent spillage on the working area.

4.5.2.2.5 Inspection and testing

The crane has been inspected and tested during fabrication and erection and will be tested during commissioning in accordance with the provisions included in the Construction Inspection and Test Plan.

The Stage A commissioning will include functional tests, operational tests, static and dynamic load testing.

Subsequent regular testing will confirm the on-going adequacy of its safety-related parameters.

4.5.2.3 Radioisotope Flask Hoist

4.5.2.3.1 Introduction

The Radioisotope Flask Hoist is located in Isotope Handling, Storage, Loading/Unloading areas and Truck Access. The hoist is used primarily for handling of transport casks for radioisotopes to and from the truck.

4.5.2.3.2 Design bases

The hoist has been designed to AS 1418 and NUREG, and fitted with double brakes to allow handling of potentially hazardous materials.

4.5.2.3.3 Description

The hoist is an electrically operated wire rope type.

4.5.2.3.4 Inspection and testing

The hoist has been inspected and tested during fabrication and erection and will be tested during Stage A commissioning in accordance with the Construction Inspection and Test Plan.

The commissioning will include functional tests, operational tests, static and dynamic load testing. Subsequent regular testing will confirm the on-going adequacy of its safety-related parameters.

4.5.2.4 Hoists and Lifting Devices

In addition to the above, hoists and lifting devices of various capacities and characteristics are distributed throughout the facility in order to carry out different operational and maintenance activities. The provision of these hoists is consistent with the ALARA approach and assists in minimising handling times in areas subject to a potential irradiation risk by simplifying the manipulation of large items of equipment.

End of Section

Table 4.5/1 Main Internal Components of the Reactor Pool

Designation
Primary cooling system inlet plenum
Reflector vessel
SSS pipeline
Chimney (riser)
Chimney structure
EMWS injection pipeline
Core grid
Fuel clamp
Lateral Control rod plate
Central control rod plate
Control rod guide box
Control rod guide box fastener
Primary cooling system internal pipeline
Pool cooling system internal pipeline
Heavy water cooling system internal pipeline
Primary cooling system flap valve
Pool cooling system flap valve
Pneumatic conveyor system – Thermal Neutron Flux Rig
Pneumatic conveyor system – Fast Neutron Flux Rig
N.A.A. pneumatic conveyor system
DNAA pneumatic conveyor system
Bulk irradiation facility
NTD silicon irradiation facility
NTD flux flattening device
Cold neutron source in- pile assembly
Hot neutron source housing
Fuel storage rack
Rig (bulk and NTD) storage rack
Control rod storage rack
Operation tool rack
Lighting system supports
General purpose working table
Internal protections

Designation
Fission counter support
Ionisation chamber container
Escape ladder
Internal maintenance platform
Siphon breaker, primary cooling system
Siphon breaker, pool cooling system
Mechanisms penetrations
Thermal neutron beam TG1, TG2 & TG3
Thermal neutron beam TG4
Cold neutron beam CG1,CG2 & CG3
Cold neutron beam CG4
Hot neutron beam HG1 & HG2
Hot water layer deflector

Table 4.5/2 Reactor Pool Main Pipelines

Identification
Primary cooling inlet
Primary cooling outlet
Reactor & Service Pool cooling system inlet
Reactor & Service Pool cooling system outlet
Reactor Pool Hot water layer inlet
Reactor Pool Hot water layer outlet
Overflow (skimming)
CRD flushing
Emergency Make Up Water system Injection Line 1
Emergency Make Up Water system Injection Line 2
RCPS inlet
RCPS outlet
Reflector Vessel Drainage Pipe
RCPS Expansion Tank Connection Line
SSS drainage
Core pressure drop measurement
CNS process lines

End of Tables

Figure 4.5/5 Control Rod Drive Room Connection – 3-D Cross Sectional View

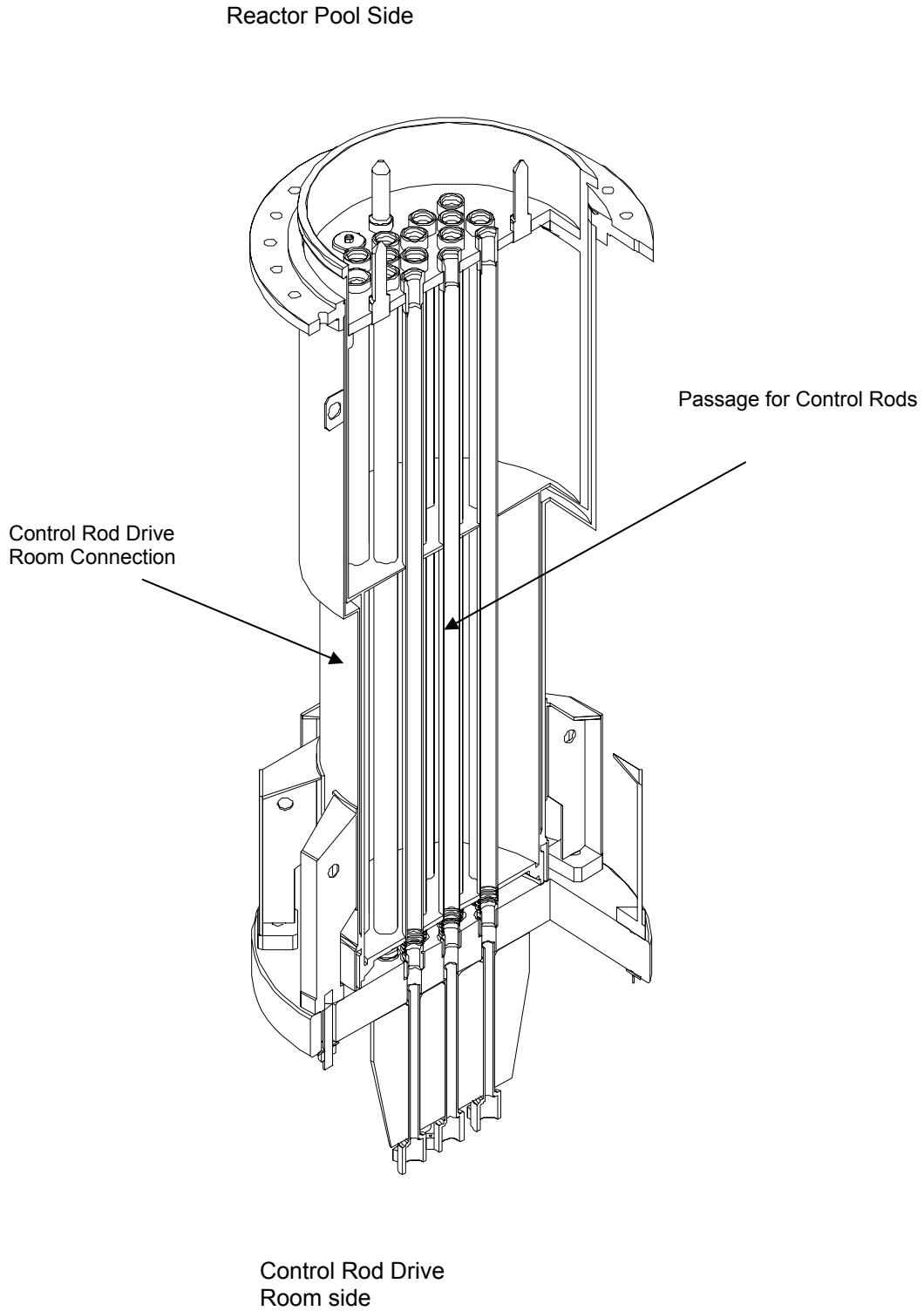

End of Figures

4.6 NEUTRON GUIDE HALL

4.6.1 Architectural Layout

As indicated in Section 4.2, the Neutron Guide Hall (NGH) is located adjacent to the Reactor Building. The design incorporates a light-weight steel-framed curved roof incorporating a central high-level lantern to provide a good level of natural lighting. On both the eastern and western sides of the Main Hall are single-storey bays containing laboratories, offices and amenities.

The perimeter walls of the Neutron Guide Hall above the side bays are clad with steel faced and fire retardant cored panels as allowed by the Building Code of Australia. The northern end wall is glazed at its lower levels. External walls of the side bays feature precast panels below window sill level.

Servicing the Main Hall is an overhead travelling gantry crane. Beneath and integral with the floor are several large services ducts for future services.

The Neutron Guide Bunker, with walls and roof slab (for radiation shielding), projects from the Reactor Building into the NGH. Multiple beam guides extend from the Bunker to research equipment described elsewhere in this report.

The bay on the western side of the NGH contains offices, meeting room and amenities for NGH technical staff, Instrument Cabins to, NGH Service Room a Clean Lab and an Electrical Lab. Exit doors to the outside of this side bay are located at its centre and at both ends.

The bay on the eastern side also contains offices and amenities, including those for Nuclear Technology staff, plus Instrument Cabins, and laboratories for Biology, Cryogenic, Furnace, High Pressure, Chemistry and the NGH Computer Room. As with the western side bay, exit doors are provided both at its centre and at either end. Immediately over the eastern side bay and adjoining the main Hall is the Group Tour Viewing Gallery accessed over bridge from the Main Entrance Building.

The Nuclear Technology area is separated from the Physics area. An Instrument workshop, Instrument Store, SCADA Computer Maintenance room and offices are located in this zone with access from the northern stair or lift in the reactor building. There are no Safety Category 1 systems or nuclear materials in this area and health physics clearance is required for plant and equipment brought into the area.

4.6.2 Structure

Floor slabs in the main NGH area have saw joints at various centres. They are poured over a smooth finished concrete blinding which is itself poured directly on the trimmed rock surface. Where the existing rock surface tends to fall away towards the northern end, mass concrete has been used from underside of the floor slab down to rock. The blinding concrete facilitated the installation of a polythene moisture barrier and provided rigid support for reinforcing bar chairs.

Thinner floor slabs as appropriate are provided under the rooms in the eastern and western side bays.

The curved high-level roof over the main NGH is supported by bow-string trusses consisting of a curved tubular top chord with a Macalloy bar bottom chord and tubular web members. When subject to wind uplift, the top chord acts as a catenary to resist the load and horizontal reactions are taken by the rods and struts external to each main

column. The Macalloy bar bottom chords are pretensioned to guard against buckling during uplift conditions.

Note that, whereas the structure of the Neutron Guide Hall is Seismic Classification 3 in the context of this project and therefore is not required to resist the OBE or SSE events, provision has been made to ensure that failure of the NGH part of the facility in these events will not adversely affect the adjacent Reactor Building and its Safety Category 1 systems. The NGH structure, along with its services, systems and connection details, has been designed to ensure that this is the case.

4.6.3 Internal Services

4.6.3.1 Cranes

4.6.3.1.1 General

Overhead cranes associated with the Neutron Guide Hall are designed to comply with AS 1418, and to withstand earthquake loads for structures in accordance with AS 1170.4

Each crane has been inspected and tested during fabrication and erection and will be tested during commissioning. The commissioning will include functional tests, operational tests, and static and dynamic load testing.

4.6.3.1.2 Neutron Guide Hall Crane

The Neutron Guide Hall Crane is located in Neutron Guide Hall Building. The crane is used primarily to manipulate research components and shielding units.

The crane is a single girder torsion box, electric overhead travelling type. There is one crab carrying the main hoist unit.

An oil/grease collection tray is provided under each mechanism to prevent oil/grease spill on the working area.

4.6.3.1.3 Neutron Guide Hall Workshop and Assembly Crane

The Neutron Guide Hall Workshop and Assembly Crane is located in Neutron Guide Hall Workshop. The crane is used primarily for maintenance purposes.

The crane is a single girder, electric overhead travelling type.

4.6.3.1.4 Other Services

Other internal services and systems in the Neutron Guide Hall and associated buildings, including electrical, fire protection, communications, security, HVAC, compressed air and hydraulics are discussed in Chapter 9 and Chapter 10 of the SAR.

4.6.4 Access to and from the Neutron Guide Hall

4.6.4.1 Normal Staff Movement within the NGH

Deliveries can be made directly to the NGH through a roller door in the north wall.

Circulation is on one level to provide direct access from experiments to all instrument cabins, meeting rooms, service rooms, electronic and clean laboratories.

Clusters of instrument cabins are located on both sides of the NGH with a central corridor between laboratories to minimise travel distances and incorporate break-out spaces/egress points at three locations along both facades. Circulation over the Neutron

Guide Bunker is provided by an elevated walkway with access from the NGH Visitor Hall and access to the Auxiliary Services Building.

4.6.4.2 Emergency Exits and Access

Emergency egress from the Neutron Guide Hall is via exits directly to an open space or through horizontal exits to an open space.

There are multiple choices available to the evacuees. There are no dead ends and travel distances comply with the BCA “deemed to satisfy” provisions.

4.6.5 Bunker and Associated Shielding

Bunker shielding has been designed on the basis of the radiation fields generated by the neutron beams. The bunker has a labyrinth access as well as removable roof and wall panels to permit maintenance of the neutron guides and beam shutters. Further details on shielding design are given in Chapter 12.

The research equipment (diffractometers, spectrometers, reflectometers, etc), as well as those sections of neutron guide installed outside the bunker, are provided with specific shielding. This shielding has been designed and tested on a case by case basis.

End of Section

4.7 AUXILIARY SERVICES BUILDING AND FACILITY SUBSTATION

4.7.1 Description

The Auxiliary Services Building (ASB) and the adjacent Facility Substation are located adjacent to the Reactor Building. The floor, walls and roof are of reinforced concrete construction to meet the seismic criteria, provide security protection and minimise noise transmission. A metal deck cladding is provided over the concrete roof to ensure effective weather proofing.

It contains electrical plant associated with the NPS and the SPS including transformer rooms, switchgear rooms and several UPS and battery rooms. Truck access is provided at various locations to facilitate service and replacement of plant and equipment.

The main parts of the ASB have been designed to resist the OBE and SSE seismic events. The remaining parts of the ASB have been designed to AS1170.4 with provisions to ensure that the Safety Category 1 areas are not affected by these seismic events. Internal Services

4.7.1.1 Auxiliary Building Crane

The Auxiliary Building Crane is located in the Auxiliary Building. The crane is used primarily for maintenance purposes.

The crane is designed to AS 1418, and will withstand normal earthquake loads for building structures in accordance with AS1170.4.

The crane is a single girder, electric overhead travelling type. There is one crab carrying the hoist unit.

The crane has been inspected and tested during fabrication and erection and will be tested during Stage A commissioning in accordance with the Construction Inspection and Testing Plan. Functional tests, operational tests, and static and dynamic load testing will be carried out.

4.7.1.2 Other Services

Other internal services and systems in the Auxiliary Services Building are discussed in Chapter 9 and Chapter 10.

End of Section

4.8 MAIN ENTRANCE, CONFERENCE CENTRE AND GROUP TOUR AREAS

4.8.1 Description

. The building has been designed for multi-purpose use during normal working hours. It has been designed to comfortably and safely accommodate the equivalent of a 50-person bus full of passengers on a conducted tour to the Neutron Guide Hall viewing gallery or the Nuclear Technology display area.

The single-storey building located adjacent to the Neutron Guide Hall includes the principal point of entry to the complex. In contrast to the cubic mass of the Reactor Building and the curved roof of the NGH, the semi-circular form of the Visitor Centre visually frames the entry precinct and focuses the visitor toward the viewing gallery (NGH Visitor Hall) at mezzanine level adjacent to the NGH. The glazed linkages to both the NGH and the Reactor Building help to alleviate the prominence of the Reactor Building.

Exposed steelwork frames the semi-circular entry colonnade, which features glazed or precast entry panels.

The Foyer leads in one direction to the bridge leading to the NGH Visitor Hall, and in the other via a Display area to the lobby of the Reactor Building. The Visitor Centre also contains male and female amenities, a Staff Meal Room, a multi-purpose Library and a Conference Room.

The building is surrounded by paving and landscaping.

The Main Entrance building structure is designed in accordance with Seismic Category 3 (refer Chapter 2), being completely separate from the Reactor Building and containing no components relevant to the functioning of the reactor. In terms of seismic resistance, it has therefore been designed in accordance with the relevant Australian Code (i.e., AS1170 Part 4) rather than the OBE and SSE requirements applicable to the Reactor Building.

End of Section

4.9 OTHER STRUCTURES

4.9.1 Cooling Towers

The Cooling Towers and Secondary Cooling System pumping systems are linked with the Reactor Building through buried piping with facilities for inspection and maintenance.

A service road allows access for maintenance and delivery of consumables into the storage area.

Design and functional details on the Cooling Towers are provided in Chapter 6, Section 6.8. These towers are a Category 2 safety function and qualified for Operating Basis Earthquake seismic events but they are not required in Safe Shutdown Earthquake safety case.

4.9.2 Reactor Stack

The facility is provided with a ventilation stack that vents the air from the containment and the general building exhaust systems.

. It is attached to the south wall of the Reactor Hall and has been designed with a failure mode that ensures adjacent Engineered Safety Features are not affected. The stack is Safety Category 2, Seismic Class 2 and Quality Level B.

The stack height, dimensions and discharge velocity ensure appropriate dispersion characteristics with minimum perturbations from the Reactor Building. Sampling points for the online stack activity monitors are provided within the building plant room as detailed in Chapter 12, Section 12.3.

End of Section